



Design Example Report

Title	<i>15 W Power Supply with Low No-load, High Efficiency Power Consumption Using TOPSwitch™-HX TOP254EN</i>
Specification	90 VAC – 265 VAC Input; 6 V, 2.5 A Output
Application	Adapter
Author	Applications Engineering Department
Document Number	DER-233
Date	September 17, 2009
Revision	1.0

Summary and Features

- Low component count
- Very low no-load input power (<140 mW at 230 VAC)
- High active mode efficiency (80%)
 - Easily meets Energy Star 2.0 efficiency requirements of 79%
 - Easily meets USA Energy Independence and Security Act 2007 requirement of 74%
 - Easily meets EU CoC v4 and EuP Tier 2 requirement of 79%
- Very high efficiency in both standby and sleep modes
- Excellent transient load response
- Hysteretic thermal overload protection with automatic recovery
- Meets limited power source requirements (<100 VA) with single point failure
- Power Integrations eSIP low-profile package
- No potting required to meet thermal specifications
- Meets radiated EMI with >6dB QP margin

PATENT INFORMATION

The products and applications illustrated herein (including transformer construction and circuits external to the products) may be covered by one or more U.S. and foreign patents, or potentially by pending U.S. and foreign patent applications assigned to Power Integrations. A complete list of Power Integrations' patents may be found at www.powerint.com. Power Integrations grants its customers a license under certain patent rights as set forth at <http://www.powerint.com/ip.htm>.

Power Integrations

5245 Hellyer Avenue, San Jose, CA 95138 USA.

Tel: +1 408 414 9200 Fax: +1 408 414 9201

www.powerint.com

Table of Contents

1	Introduction.....	4
2	Power Supply Specification	5
3	Schematic.....	6
4	Circuit Description	7
4.1	Input EMI Filtering	7
4.2	TOPSwitch-HX Primary	7
4.3	Energy Efficiency.....	7
4.4	Output Power Limiting with Line Voltage.....	7
4.5	Output Rectification and Filtering	7
4.6	Thermal Overload Protection.....	8
5	PCB Layout	9
6	Bill of Materials	10
7	Transformer Specification.....	11
7.1	Electrical Diagram	11
7.2	Electrical Specifications.....	11
7.3	Materials.....	11
7.4	Transformer Build Diagram	12
7.5	Transformer Construction.....	12
8	Transformer Design Spreadsheet.....	13
9	Mechanical Drawings	17
9.1	TOP254EN (U1) Heat Sink.....	17
9.2	Output Diode (D8) Heat Sink.....	18
10	Performance Data	19
10.1	Full Load Efficiency	19
10.2	Active Mode Efficiency	20
10.3	Energy Efficiency Requirements	21
10.3.1	USA Energy Independence and Security Act 2007	22
10.3.2	ENERGY STAR EPS Version 2.0	22
10.4	No-load Input Power.....	23
10.5	Available Standby Output Power	24
10.6	Regulation	25
10.6.1	Load	25
10.6.2	Line	26
11	Thermal Performance	27
12	Waveforms.....	28
12.1	Drain Voltage and Current, Normal Operation.....	28
12.2	Output Voltage Start-up Profile.....	28
12.3	Drain Voltage and Current Start-up Profile	29
12.4	Load Transient Response (75% to 100% Load Step)	29
12.5	Output Ripple Measurements.....	30
12.5.1	Ripple Measurement Technique	30
12.5.2	Measurement Results	31
13	Control Loop Measurements.....	32
13.1	115 VAC Maximum Load.....	32



13.2	230 VAC Maximum Load	32
14	Conducted EMI	33
15	Radiated EMI	37
16	Revision History	39

Important Note:

Although this board is designed to satisfy safety isolation requirements, the engineering prototype has not been agency approved. Therefore, all testing should be performed using an isolation transformer to provide the AC input to the prototype board.



1 Introduction

This document is an engineering report describing an adapter power supply utilizing a TOPSwitch-HX TOP254EN. This power supply is intended as a general purpose evaluation platform that operates from universal input and provides a 6 V, continuous 15 W output.

The adapter meets Energy Star 2.0 >79% average-efficiency, no-load <150 mW at 230 VAC and CISPR conducted and radiated EMI with more than 6dB margin.

This power supply offers thermal overload protection with auto-recovery using large hysteresis.

The document contains the power supply specification, schematic, bill of materials, transformer documentation, printed circuit layout, and performance data. Conducted and radiated EMI results are provided as well.



Figure 1 – Populated Circuit Board Photograph.



2 Power Supply Specification

The table below represents the minimum acceptable performance of the design. Actual performance is listed in the results section.

Description	Symbol	Min	Typ	Max	Units	Comment
Input						
Voltage	V_{IN}	90		265	VAC	2 Wire – no P.E.
Frequency	f_{LINE}	47	50/60	64	Hz	
No-load Input Power (230 VAC)				0.14	W	
Output						
Output Voltage	V_{OUT}		6		V	± 5% 20 MHz bandwidth
Output Ripple Voltage	V_{RIPPLE}		60		mV	
Output Current	I_{OUT}			2.5	A	
Total Output Power						
Continuous Output Power	P_{OUT}			15	W	
Efficiency						
Full Load	η	80			%	Measured at P_{OUT} 25 °C
Required average efficiency at 25, 50, 75 and 100 % of P_{OUT}	$\eta_{ES2.0}$	79			%	Per ENERGY STAR V2.0
Environmental						
Conducted EMI						1.2/50 μ s surge, IEC 1000-4-5, Series Impedance: Differential Mode: 2 Ω Common Mode: 12 Ω
Safety						
Line Surge						
Differential Mode (L1-L2) Common mode (L1/L2-PE)				1 2	kV kV	
Ambient Temperature	T_{AMB}	0	25	40	°C	Free convection, sea level



4 Circuit Description

This design centers around the TOP254EN in a flyback topology for a low no-load, high efficiency and compact power supply operating from universal input and providing a 6 V, 15 W output.

4.1 Input EMI Filtering

Fuse F1 provides catastrophic fault protection to the circuit, and isolates it from the AC source. Diodes D1 through D4 rectify the AC input. Capacitor C1 and C2 filter the resulting DC. Bulk capacitor C1 also forms part of the EMI filter with L1 to reduce differential-mode EMI. A common mode inductor L1 filters common-mode EMI. This input filter eliminates additional X class capacitors and associated discharge resistors, minimizing no-load input power.

4.2 TOPSwitch-HX Primary

This adapter power supply employs the TOPSwitch-HX TOP254EN (U1), which integrates a high voltage MOSFET and PWM controller.

132 kHz operation was chosen to minimize transformer size and maximize efficiency by reducing the number of turns required compared to operation at 66 kHz. This high frequency operation has no impact on efficiency or EMI thanks to PI power MOSFET technology and proprietary frequency jitter feature.

The TOP254EN regulates the output by adjusting the duty cycle based on the current into its CONTROL (C) pin. The power supply output voltage is sensed on the secondary side by shunt regulator U2 and provides a feedback signal to the primary side through optocoupler U3.

4.3 Energy Efficiency

The EcoSmart[®] feature of U1 provides constant efficiency over the entire load range. The proprietary Multi-cycle Modulation function automatically achieves this performance, eliminating special operating modes triggered at specific loads, which greatly simplifies circuit design.

4.4 Output Power Limiting with Line Voltage

To provide constant output power with varying line voltage, R1, R5, and R6 reduce the internal current limit of U1 as the line voltage increases. This allows the supply to limit the output power to <100 VA (limited power source safety requirement) at high line and deliver the rated output power at low line.

4.5 Output Rectification and Filtering

A single 20 A, 45 V Schottky diode was used to meet the required efficiency. The 45 V rating provided >20% voltage stress de-rating. Output filtering is provided by C11 and C12. A snubber network on the output formed by R11 and C14 attenuates high-frequency ringing for reduced EMI. These two components were chosen with smaller values to



allow high-frequency ringing to be damped while keeping any power dissipation they cause at no-load to a minimum. Inductor L2 and capacitor C13 form an output second stage filter to reduce switching frequency ripple and noise.

Capacitor C10 was added to shrink the loop area formed by the secondary winding output diode and output capacitors. This improved both conducted and radiated EMI. The values of C11, C12, L2 and C13 may be adjusted depending on the specific output ripple specification.

4.6 Thermal Overload Protection

IC U1 has an integrated, 100% tested, accurate hysteretic thermal-overload protection feature. If the junction temperature reaches +142 °C (during a fault condition), U1 shuts down. It automatically recovers once the junction temperature has decreased by approximately 75 °C.



5 PCB Layout

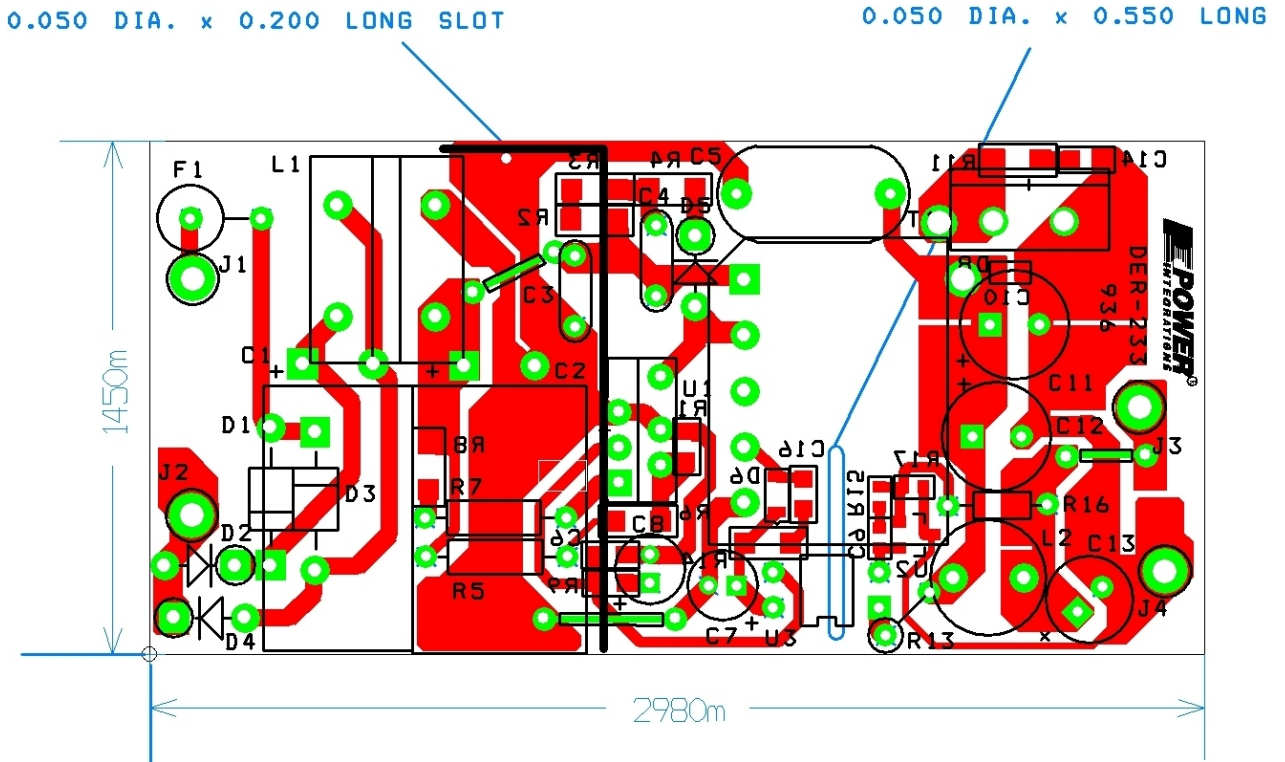

Figure 3 – Printed Circuit Layout (2980 mils. x 1450 mils).



6 Bill of Materials

Item	Qty	Ref Des	Description	Mfg Part Number	Manufacturer
1	1	C1	10 μ F, 400 V, Electrolytic, Low ESR, 2.9 Ω , (10 x 20)	EKMX401ELL100MJ20S	Nippon Chemi-Con
2	1	C2	22 μ F, 400 V, Electrolytic, High Ripple, (12.5 x 18)	Not Provided	Samxon
3	1	C3	2.2 nF, 1 kV, Disc Ceramic	NCD222K1KVY5FF	NIC Components
4	1	C4	0.001 μ F, 1 kV, Disc Ceramic	562R10TSD10	Vishay
5	1	C5	2.2 nF, 250 VAC, Film, X1Y1	CD12-E2GA222MYNS	TDK
6	1	C6	100 nF, 25 V, Ceramic, X7R, 0805	ECJ-2VB1E104K	Panasonic
7	1	C7	10 μ F, 50 V, Electrolytic, Gen. Purpose, (5 x 11)	KME50VB10RM5X11LL	Nippon Chemi-Con
8	1	C8	47 μ F, 10 V, Electrolytic, Gen. Purpose, (5 x 11)	KME10VB22RM5X11LL	Nippon Chemi-Con
9	2	C9 C10	100 nF 25 V, Ceramic, X7R, 0603	ECJ-1VB1E104K	Panasonic
10	2	C11 C12	1000 μ F, 10 V, Electrolytic, Low ESR, (8 x 16)	10MCZ1000M8X16	Rubycon
11	1	C13	220 μ F, 10 V, Electrolytic, Very Low ESR, 130 m Ω , (6.3 x 11)	EKZE100ELL221MF11D	Nippon Chemi-Con
12	1	C14	1 nF, 100 V, Ceramic, X7R, 0805	ECJ-2VB2A102K	Panasonic
13	1	C16	100 pF, 100 V, Ceramic, COG, 0805	C0805C101J1GACTU	Kemet
14	4	D1 D2 D3 D4	1000 V, 1 A, Rectifier, DO-41	1N4007-E3/54	Vishay
15	1	D5	1000 V, 1 A, Fast Recovery Diode, DO-41	FR107-T-F	Diodes, Inc.
16	1	D6	250 V, 0.2 A, Fast Switching, 50 ns, SOD-323	BAV21WS-7-F	Diodes, Inc.
17	1	D8	45 V, 20 A, Schottky, TO-220AC	VS-20TQ045PBF	Vishay
18	1	F1	2 A, 250 V, Slow, 5 mm x 20 mm, Axial	230002	Littlefuse
19	1	L1	5 mH, 0.3 A, Common Mode Choke	SU9V-03050	Tokin
20	1	L2	3.3 μ H, 5.0 A	Custom	Toko
21	1	R1	8.87 k Ω , 1%, 1/8 W, Metal Film, 0805	ERJ-6ENF8871V	Panasonic
22	2	R2 R3	150 k Ω , 5%, 1/4 W, Metal Film, 1206	ERJ-8GEYJ154V	Panasonic
23	2	R4 R11	47 Ω , 5%, 1/4 W, Metal Film, 1206	ERJ-8GEYJ470V	Panasonic
24	1	R14	22 Ω , 5%, 1/4 W, Metal Film, 1206	ERJ-8GEYJ220V	Panasonic
25	2	R5 R6	3.3 M Ω , 5%, 1/4 W, Metal Film, 1206	ERJ-8GEYJ335V	Panasonic
26	2	R7 R8	2 M Ω , 5%, 1/4 W, Metal Film, 1206	ERJ-8GEYJ205V	Panasonic
27	1	R9	18 Ω , 5%, 1/8 W, Metal Film, 0805	ERJ-6GEYJ180V	Panasonic
28	1	R13	470 Ω , 5%, 1/4 W, Carbon Film	CFR-25JB-470R	Yageo
29	1	R15	1 k Ω , 5%, 1/10 W, Metal Film, 0603	ERJ-3GEYJ102V	Panasonic
30	1	R16	5.62 k Ω , 1%, 1/16 W, Metal Film, 0603	ERJ-3EKF5621V	Panasonic
31	1	R17	3.92 k Ω , 1%, 1/16 W, Metal Film, 0603	ERJ-3EKF3921V	Panasonic
32	1	T1	Bobbin, EE22, Vertical, 10 pins	BE-22-1110CP	TDK
33	1	U1	TOPSwitch-HX, eSIP-7C	TOP254EN	Power Integrations
34	1	U2	IC, REG ZENER SHUNT ADJ SOT-23	LM431AIM3/NOPB	National Semi
35	1	U3	Optocoupler, 35 V, CTR 200-300%, 4-DIP	PC817C	Sharp



7 Transformer Specification

7.1 Electrical Diagram

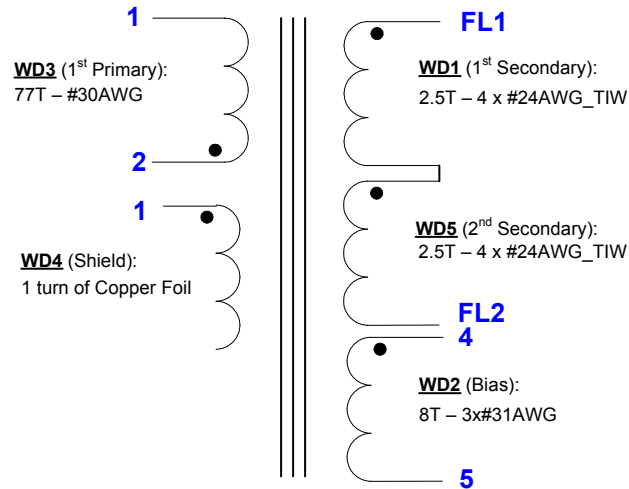

Figure 4 – Transformer Electrical Diagram.

7.2 Electrical Specifications

Electrical Strength	1 second, 60 Hz, from pins 1-5 to pins FL1-FL2 .	3000 VAC
Primary Inductance	Pins 1-2, all other windings open, measured at 132 kHz, 0.4 V _{RMS} .	1002 μH, ±10%
Resonant Frequency	Pins 1-2, all other windings open.	1 MHz (Min.)
Primary Leakage Inductance	Pins 1-2, with pins FL1-FL2 shorted, measured at 132 kHz, 0.4 V _{RMS} .	19 μH (Max.)

7.3 Materials

Item	Description
[1]	Core: EE22 partner with I22 PC44. Gapped for AL of 169 nH/T ² .
[2]	Bobbin: EE22, vertical, 10 pins (5/5), (Note: pins 6-10 are removed).
[3]	Magnet wire: #31 AWG (double coated).
[4]	Magnet wire: #30 AWG (double coated).
[5]	Magnet wire: #24 AWG – Triple Insulated Wire.
[6]	Cooper foil tape: 2 mils thick, 8.5 mm wide, to be attached with tape item [8]. (See figure 6).
[7]	Tape: 3M 1298 polyester film, 9.0 mm wide.



7.4 Transformer Build Diagram

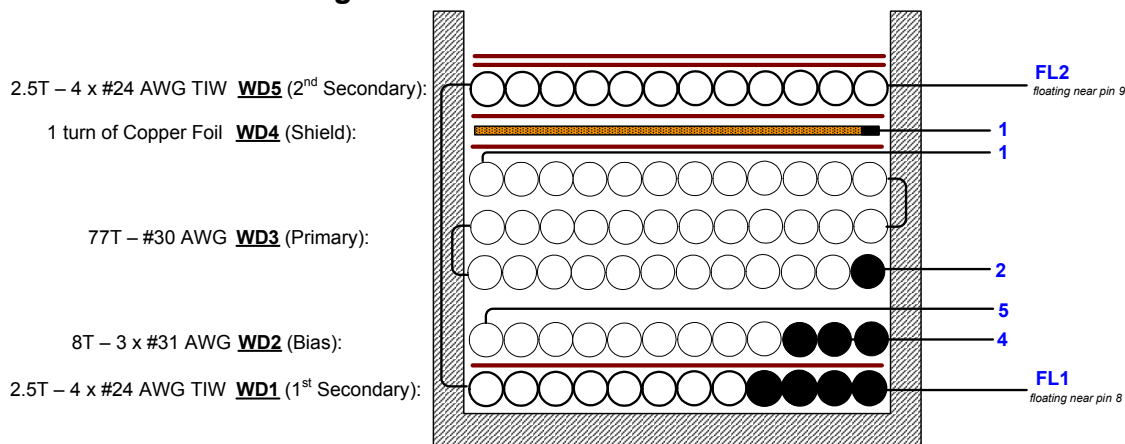

Figure 5 – Transformer Build Diagram.

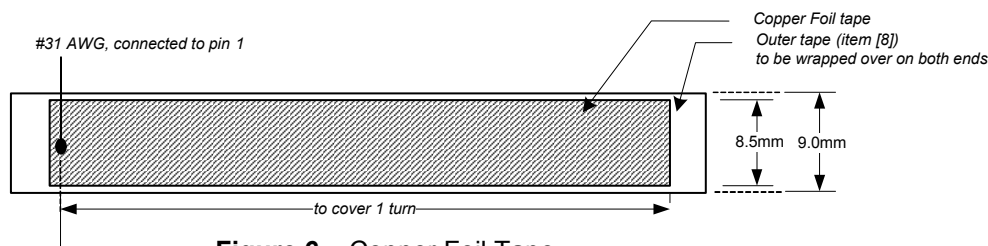

Figure 6 – Copper Foil Tape.

7.5 Transformer Construction

Bobbin Preparation	Position the bobbin on the mandrel so pin side on the right hand side. Winding direction is clockwise direction.
WD1 1st Secondary	Leave start end about 1 inch at pin 9 position for FL1, wind 2.5 quadfilar turns of item [5] from right to left and let the remaining wires hanging to the leftmost of the bobbin. Note that the remaining wires will be used in WD5.
Insulation	1 layer of tape item [7].
WD2 Bias	Start at pin 4, wind 8 trifilar turns of item [3] from right to left, spread the wires evenly on the bobbin, and bring the wires back to the left to terminate at pin 5.
Insulation	1 layer of tape item [7].
WD3 Primary	Start at pin 2, wind 26 turns of item [4], from right to left for the first layer, then from left to right also about 26 turns for second layer, and wind 25 turns for third layer. Terminate at pin 1. (Total for this winding is 77 turns).
Insulation	1 layer of tape item [7].
WD4 Shield	Apply item [6] for 1 turn, tape should be overlapped to hold in place.
Insulation	1 layer of tape item [7].
WD5 2nd Secondary	Continue winding the remaining wires form WD1 for 2.5 turns and leave 1 inch near pin 9.
Insulation	2 layers of tape item [7].
Finish	Gap cores to get an inductance of 1002 μ H. Assemble and secure the cores with tape.



8 Transformer Design Spreadsheet

ACDC_TOPSwitchHX_100208; Rev.1.10; Copyright Power Integrations 2008	INPUT	INFO	OUTPUT	UNIT	TOP_HX_100208: TOPSwitch-HX Continuous/Discontinuous Flyback Transformer Design Spreadsheet
ENTER APPLICATION VARIABLES					
VACMIN	88			Volts	Minimum AC Input Voltage
VACMAX	265			Volts	Maximum AC Input Voltage
fL	50			Hertz	AC Mains Frequency
VO	6			Volts	Output Voltage (main)
PO_AVG	15			Watts	Average Output Power
PO_PEAK	18		18.00	Watts	Peak Output Power
N	0.8			%/100	Efficiency Estimate
Z	0.5				Loss Allocation Factor
VB	10	Info		Volts	Ensure proper operation at no load.
tC	3			mSeconds	Bridge Rectifier Conduction Time Estimate
CIN	32		32	uFarads	Input Filter Capacitor
ENTER TOPSWITCH-HX VARIABLES					
TOPSwitch-HX	TOP254EN			Universal / Peak	115 Doubled/230V
Chosen Device		TOP254EN	Power Out	43 W / 43 W	62W
KI	0.9				External Ilimit reduction factor (KI=1.0 for default ILIMIT, KI <1.0 for lower ILIMIT)
ILIMITMIN_EXT			1.088	Amps	Use 1% resistor in setting external ILIMIT
ILIMITMAX_EXT			1.252	Amps	Use 1% resistor in setting external ILIMIT
Frequency (F)=132kHz, (H)=66kHz	F		F		Select 'H' for Half frequency - 66kHz, or 'F' for Full frequency - 132kHz
fS			132000	Hertz	TOPSwitch-HX Switching Frequency: Choose between 132 kHz and 66 kHz
fSmin			119000	Hertz	TOPSwitch-HX Minimum Switching Frequency
fSmax			145000	Hertz	TOPSwitch-HX Maximum Switching Frequency
High Line Operating Mode			VF		Full Frequency, Jitter enabled
VOR	100			Volts	Reflected Output Voltage
VDS			10	Volts	TOPSwitch on-state Drain to Source Voltage
VD	0.5			Volts	Output Winding Diode Forward Voltage Drop
VDB	0.7			Volts	Bias Winding Diode Forward Voltage Drop
KP	0.48				Ripple to Peak Current Ratio (0.3 < KRP < 1.0 : 1.0 < KDP < 6.0)
PROTECTION FEATURES					
LINE SENSING					
VUV_STARTUP			98	Volts	Minimum DC Bus Voltage at which the power supply will start-up
VOV_SHUTDOWN			490	Volts	Typical DC Bus Voltage at which power supply will shut-down (Max)
RLS			4.4	M-ohms	Use two standard, 2.2 M-Ohm, 5% resistors in series for line sense functionality.



OUTPUT OVERVOLTAGE					
VZ			0	Volts	Zener Diode rated voltage for Output Overvoltage shutdown protection
RZ			5.1	k-ohms	Output OVP resistor. For latching shutdown use 20 ohm resistor instead
OVERLOAD POWER LIMITING					
Overload Current Ratio at VMAX			1.2		Enter the desired margin to current limit at VMAX. A value of 1.2 indicates that the current limit should be 20% higher than peak primary current at VMAX
Overload Current Ratio at VMIN		Info	1.59		Your margin to current limit at low line is high. Reduce KI to 0.76 (if possible).
ILIMIT_EXT_VMIN			0.65	A	Peak primary Current at VMIN
ILIMIT_EXT_VMAX			0.44	A	Peak Primary Current at VMAX
RIL			8.95	k-ohms	Current limit/Power Limiting resistor.
RPL			8.58	M-ohms	Power Limiting resistor
ENTER TRANSFORMER CORE/CONSTRUCTION VARIABLES					
Core Type	EE22		EE22		Core Type
Core		EE22		P/N:	PC40EE22-Z
Bobbin		EE22_BOBBIN		P/N:	BE-22-118CP
AE			0.42	cm ²	Core Effective Cross Sectional Area
LE			3.93	cm	Core Effective Path Length
AL			2400	nH/T ²	Ungapped Core Effective Inductance
BW			8.45	mm	Bobbin Physical Winding Width
M	0			mm	Safety Margin Width (Half the Primary to Secondary Creepage Distance)
L	3				Number of Primary Layers
NS	5		5		Number of Secondary Turns
DC INPUT VOLTAGE PARAMETERS					
VMIN			75	Volts	Minimum DC Input Voltage
VMAX			375	Volts	Maximum DC Input Voltage
CURRENT WAVEFORM SHAPE PARAMETERS					
DMAX			0.61		Maximum Duty Cycle (calculated at PO_PEAK)
Iavg			0.25	Amps	Average Primary Current (calculated at average output power)
IP			0.65	Amps	Peak Primary Current (calculated at Peak output power)
IR			0.26	Amps	Primary Ripple Current (calculated at average output power)
IRMS			0.33	Amps	Primary RMS Current (calculated at average output power)
TRANSFORMER PRIMARY DESIGN PARAMETERS					
LP			1002	uHenries	Primary Inductance
LP Tolerance	5		5		Tolerance of Primary Inductance
NP			77		Primary Winding Number of Turns
NB			8		Bias Winding Number of Turns
ALG			169	nH/T ²	Gapped Core Effective Inductance
BM			2018	Gauss	Maximum Flux Density at PO, VMIN (BM<3000)



BP			4077	Gauss	Peak Flux Density (BP<4200) at ILIMITMAX and LP_MAX. Note: Recommended values for adapters and external power supplies <=3600 Gauss
BAC			484	Gauss	AC Flux Density for Core Loss Curves (0.5 X Peak to Peak)
ur			1787		Relative Permeability of Ungapped Core
LG			0.29	mm	Gap Length (Lg > 0.1 mm)
BWE			25.35	mm	Effective Bobbin Width
OD			0.33	mm	Maximum Primary Wire Diameter including insulation
INS			0.05	mm	Estimated Total Insulation Thickness (= 2 * film thickness)
DIA			0.27	mm	Bare conductor diameter
AWG			30	AWG	Primary Wire Gauge (Rounded to next smaller standard AWG value)
CM			102	Cmils	Bare conductor effective area in circular mils
CMA			312	Cmils/Amp	Primary Winding Current Capacity (200 < CMA < 500)
Primary Current Density (J)			6.43	Amps/mm ²	Primary Winding Current density (3.8 < J < 9.75)
TRANSFORMER SECONDARY DESIGN PARAMETERS (SINGLE OUTPUT EQUIVALENT)					
Lumped parameters					
ISP			10.01	Amps	Peak Secondary Current
ISRMS			4.05	Amps	Secondary RMS Current
IO_PEAK			3.00	Amps	Secondary Peak Output Current
IO			2.50	Amps	Average Power Supply Output Current
IRIPPLE			3.18	Amps	Output Capacitor RMS Ripple Current
CMS			809	Cmils	Secondary Bare Conductor minimum circular mils
AWGS			21	AWG	Secondary Wire Gauge (Rounded up to next larger standard AWG value)
DIAS			0.73	Mm	Secondary Minimum Bare Conductor Diameter
ODS			1.69	Mm	Secondary Maximum Outside Diameter for Triple Insulated Wire
INSS			0.48	Mm	Maximum Secondary Insulation Wall Thickness
VOLTAGE STRESS PARAMETERS					
VDRAIN			575	Volts	Maximum Drain Voltage Estimate (Includes Effect of Leakage Inductance)
PIVS			30	Volts	Output Rectifier Maximum Peak Inverse Voltage
PIVB			50	Volts	Bias Rectifier Maximum Peak Inverse Voltage
TRANSFORMER SECONDARY DESIGN PARAMETERS (MULTIPLE OUTPUTS)					
1st output					
VO1			6	Volts	Output Voltage
IO1_AVG			2.50	Amps	Average DC Output Current
PO1_AVG			15.00	Watts	Average Output Power
VD1			0.5	Volts	Output Diode Forward Voltage Drop
NS1			5.00		Output Winding Number of Turns
ISRMS1			4.047	Amps	Output Winding RMS Current
IRIPPLE1			3.18	Amps	Output Capacitor RMS Ripple Current



PIVS1			30	Volts	Output Rectifier Maximum Peak Inverse Voltage
CMS1			809	Cmils	Output Winding Bare Conductor minimum circular mils
AWGS1			21	AWG	Wire Gauge (Rounded up to next larger standard AWG value)
DIAS1			0.73	mm	Minimum Bare Conductor Diameter
ODS1			1.69	mm	Maximum Outside Diameter for Triple Insulated Wire
2nd output					
VO2				Volts	Output Voltage
IO2_AVG				Amps	Average DC Output Current
PO2_AVG			0.00	Watts	Average Output Power
VD2			0.7	Volts	Output Diode Forward Voltage Drop
NS2			0.54		Output Winding Number of Turns
ISRMS2			0.000	Amps	Output Winding RMS Current
IRIPPLE2			0.00	Amps	Output Capacitor RMS Ripple Current
PIVS2			3	Volts	Output Rectifier Maximum Peak Inverse Voltage
CMS2			0	Cmils	Output Winding Bare Conductor minimum circular mils
AWGS2			N/A	AWG	Wire Gauge (Rounded up to next larger standard AWG value)
DIAS2			N/A	mm	Minimum Bare Conductor Diameter
ODS2			N/A	mm	Maximum Outside Diameter for Triple Insulated Wire
3rd output					
VO3				Volts	Output Voltage
IO3_AVG				Amps	Average DC Output Current
PO3_AVG			0.00	Watts	Average Output Power
VD3			0.7	Volts	Output Diode Forward Voltage Drop
NS3			0.54		Output Winding Number of Turns
ISRMS3			0.000	Amps	Output Winding RMS Current
IRIPPLE3			0.00	Amps	Output Capacitor RMS Ripple Current
PIVS3			3	Volts	Output Rectifier Maximum Peak Inverse Voltage
CMS3			0	Cmils	Output Winding Bare Conductor minimum circular mils
AWGS3			N/A	AWG	Wire Gauge (Rounded up to next larger standard AWG value)
DIAS3			N/A	mm	Minimum Bare Conductor Diameter
ODS3			N/A	mm	Maximum Outside Diameter for Triple Insulated Wire
Total Continuous Output Power			15	Watts	Total Continuous Output Power
Negative Output			N/A		If negative output exists enter Output number; eg: If VO2 is negative output, enter 2



9 Mechanical Drawings

The following mechanical drawings are for the custom mechanical designs used in this power supply.

9.1 TOP254EN (U1) Heat Sink

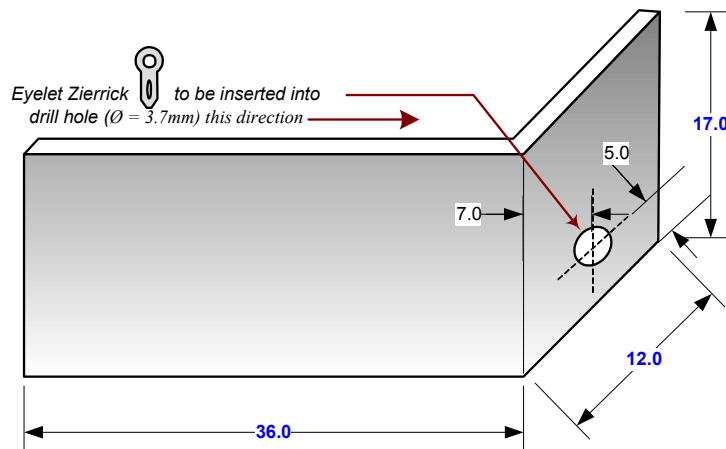
**Note:**

- Unit measurement: mm.
- Thickness: 0.67mm.
- Material: Zinc Plated Steel

Figure 7 – U1 Heat Sink.

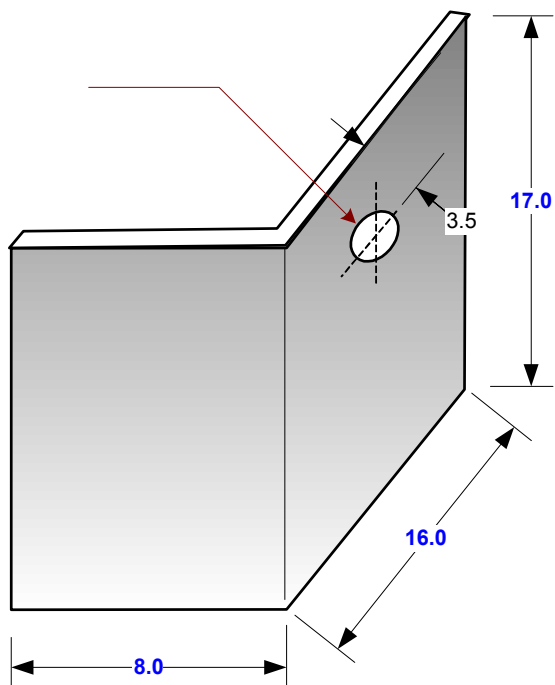

9.2 Output Diode (D8) Heat Sink

**Note:**

- Unit measurement: mm.
- Thickness: 0.67mm.
- Material: Zinc Plated Steel

Figure 8 – Output Rectifier Heat Sink.



10 Performance Data

All tests were performed at room temperature with 90 V / 50 Hz, 115 V / 60 Hz, 230 V / 50 Hz, and 265 V / 50 Hz line-input voltages and corresponding frequencies unless otherwise noted. The power supply was put in a plastic case and allowed to warm up for 30 minutes at full load. The input was provided via a 1 meter AC cable. The output was measured at the end of a 1.8 meters cable with impedance of 90 mΩ.

10.1 Full Load Efficiency

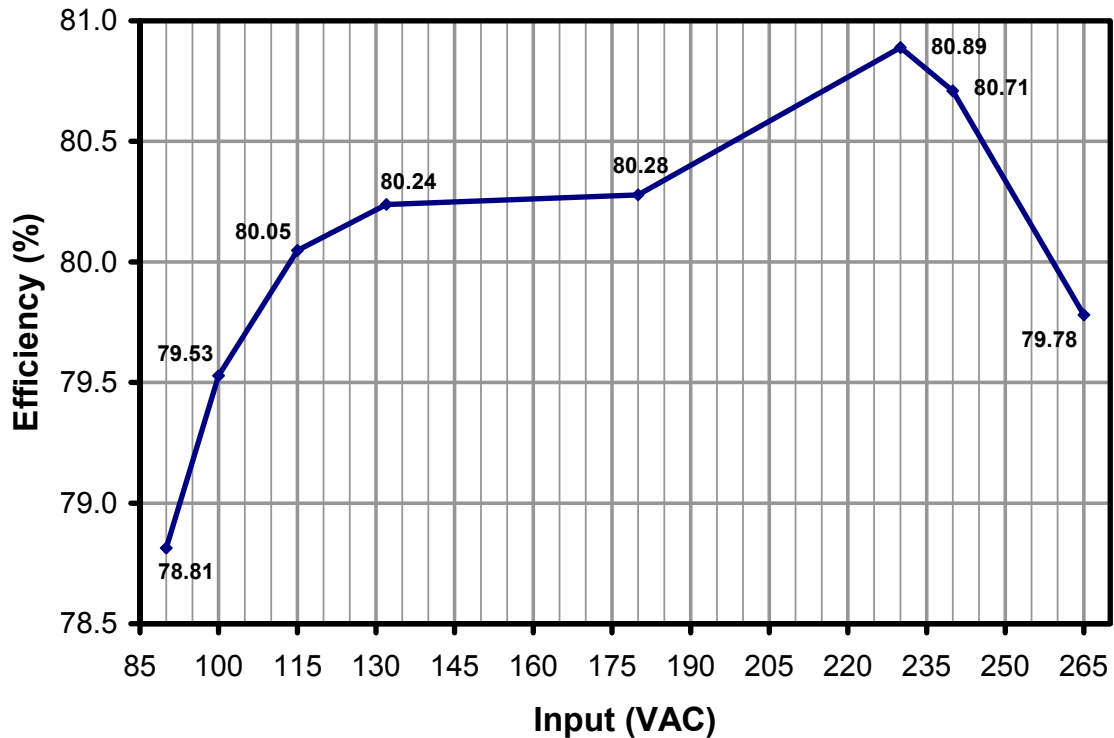

Figure 9 – Efficiency vs. Input Voltage, Room Temperature, 60 Hz.



10.2 Active Mode Efficiency

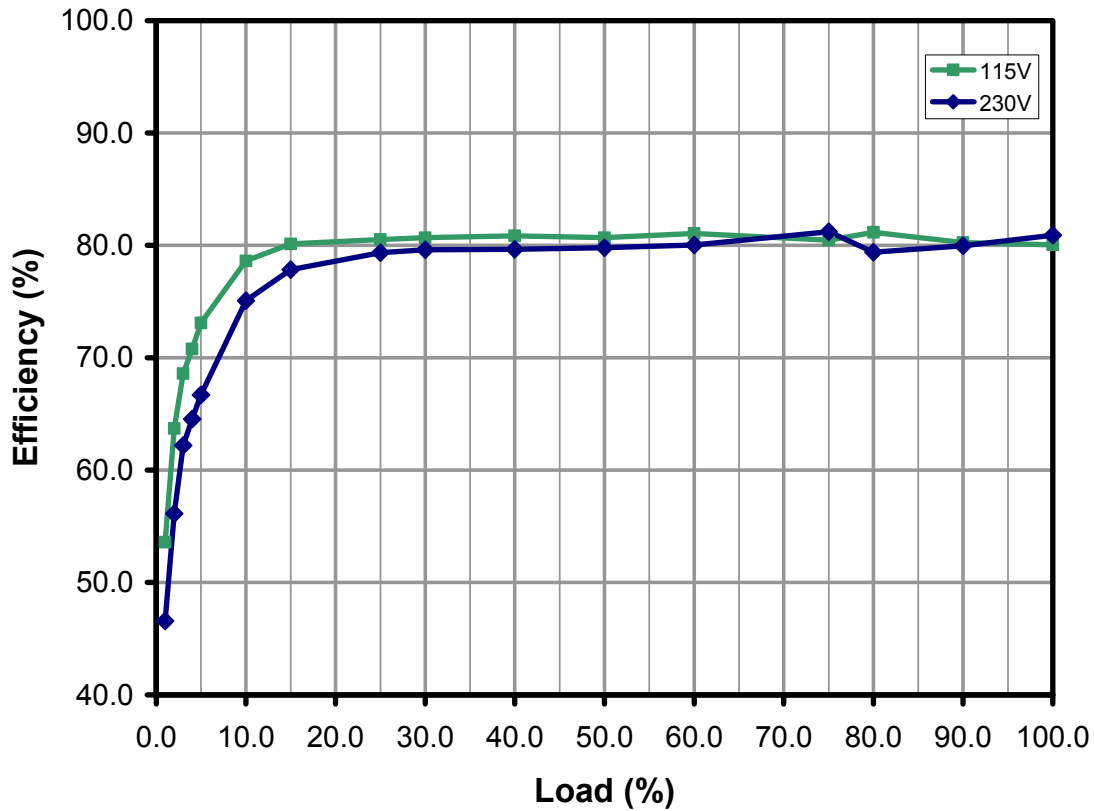

Figure 10 – Efficiency vs. Load.

Percent of Full Load	Efficiency (%)	
	115 VAC	230 VAC
25	80.53	79.35
50	80.68	79.79
75	80.47	81.22
100	80.05	80.89
Average	80.43	80.31
US EISA (2007) requirement	74	
ENERGY STAR EPS v2, EC CoC v4, EUP Tier 2	79	



10.3 Energy Efficiency Requirements

The external power supply requirements below all require meeting active mode efficiency and no-load input power limits. Minimum active mode efficiency is defined as the average efficiency of 25, 50, 75 and 100% of output current (based on the nameplate output current rating).

For adapters that are single input voltage only then the measurement is made at the rated single nominal input voltage (115 VAC or 230 VAC), for universal input adapters the measurement is made at both nominal input voltages (115 VAC and 230 VAC).

To meet the standard the measured average efficiency (or efficiencies for universal input supplies) must be greater than or equal to the efficiency specified by the standard.

The test method can be found here:

http://www.energystar.gov/ia/partners/prod_development/downloads/power_supplies/EP_SupplyEffic_TestMethod_0804.pdf

For the latest up to date information please visit the PI Green Room:

<http://www.powerint.com/greenroom/regulations.htm>



10.3.1 USA Energy Independence and Security Act 2007

This legislation mandates all single output single output adapters, including those provided with products, manufactured on or after July 1st, 2008 must meet minimum active mode efficiency and no load input power limits.

Active Mode Efficiency Standard Models

Nameplate Output (P_o)	Minimum Efficiency in Active Mode of Operation
< 1 W	$0.5 \times P_o$
≥ 1 W to ≤ 51 W	$0.09 \times \ln(P_o) + 0.5$
> 51 W	0.85

Ln = natural logarithm

No-load Energy Consumption

Nameplate Output (P_o)	Maximum Power for No-load AC-DC EPS
All	≤ 0.5 W

This requirement supersedes the legislation from individual US States (for example CEC in California).

10.3.2 ENERGY STAR EPS Version 2.0

This specification takes effect on November 1st, 2008.

Active Mode Efficiency Standard Models

Nameplate Output (P_o)	Minimum Efficiency in Active Mode of Operation
≤ 1 W	$0.48 \times P_o + 0.14$
> 1 W to ≤ 49 W	$0.0626 \times \ln(P_o) + 0.622$
> 49 W	0.87

ln = natural logarithm

Active Mode Efficiency Low Voltage Models ($V_o < 6$ V and $I_o \geq 550$ mA)

Nameplate Output (P_o)	Minimum Efficiency in Active Mode of Operation
≤ 1 W	$0.497 \times P_o + 0.067$
> 1 W to ≤ 49 W	$0.075 \times \ln(P_o) + 0.561$
> 49 W	0.86

ln = natural logarithm

No-load Energy Consumption (both models)

Nameplate Output (P_o)	Maximum Power for No-load AC-DC EPS
0 to < 50 W	≤ 0.3 W
≥ 50 W to ≤ 250 W	≤ 0.5 W



10.4 No-load Input Power

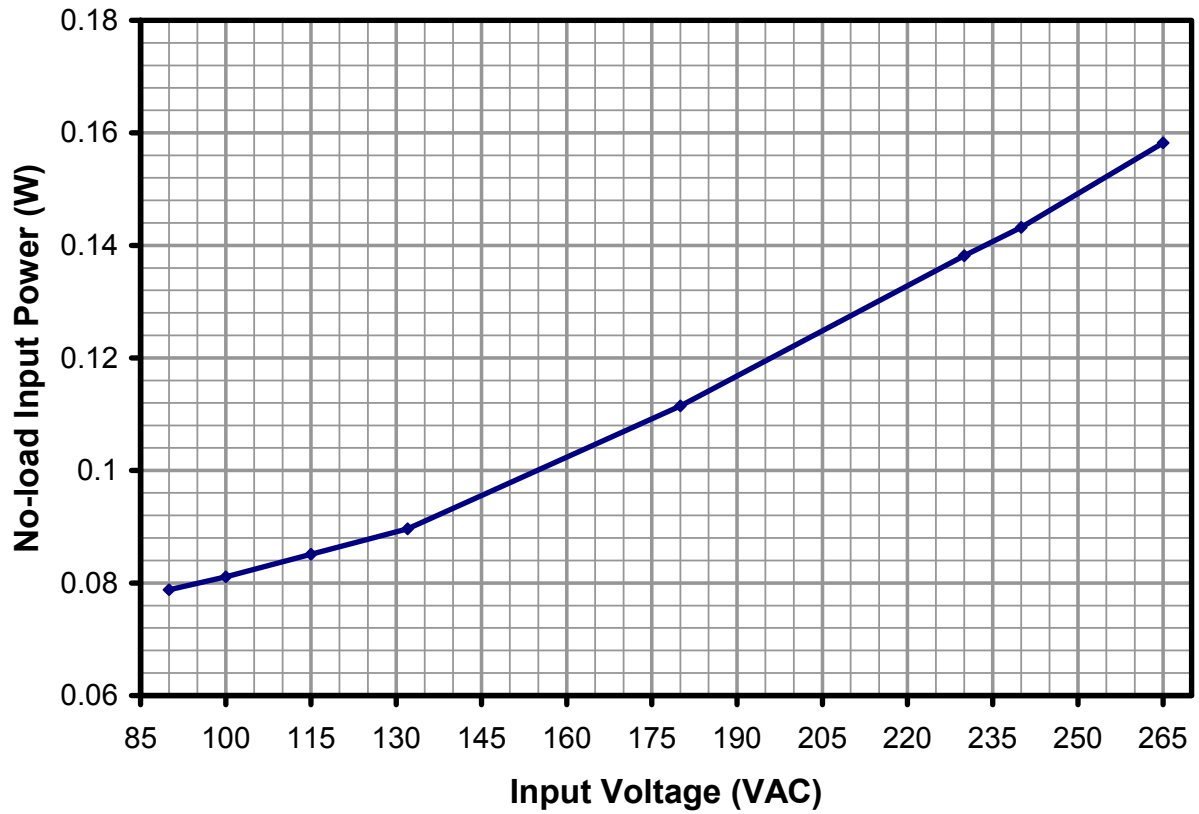

Figure 11 – Zero Load Input Power vs. Input Line Voltage, Room Temperature.



10.5 Available Standby Output Power

The chart below shows the available output power vs line voltage for an input power of 1 W, 2 W and 3 W.

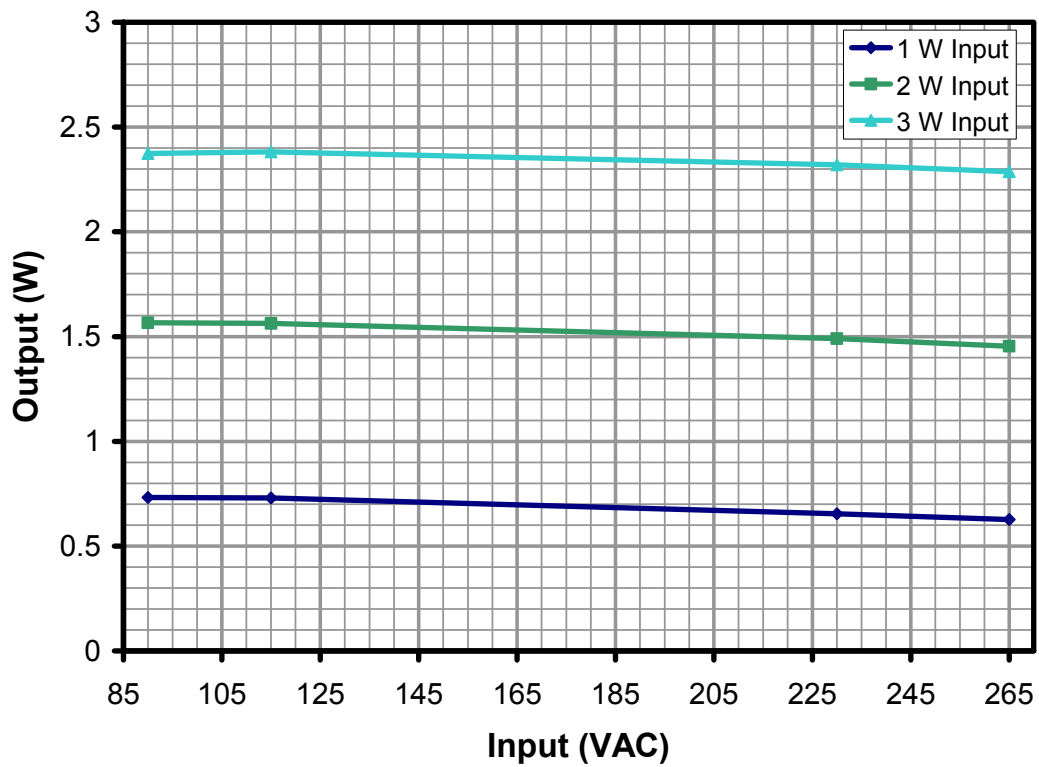

Figure 12 – Available Standby Output Power vs. Input Line Voltage, Room Temperature.



10.6 Regulation

10.6.1 Load

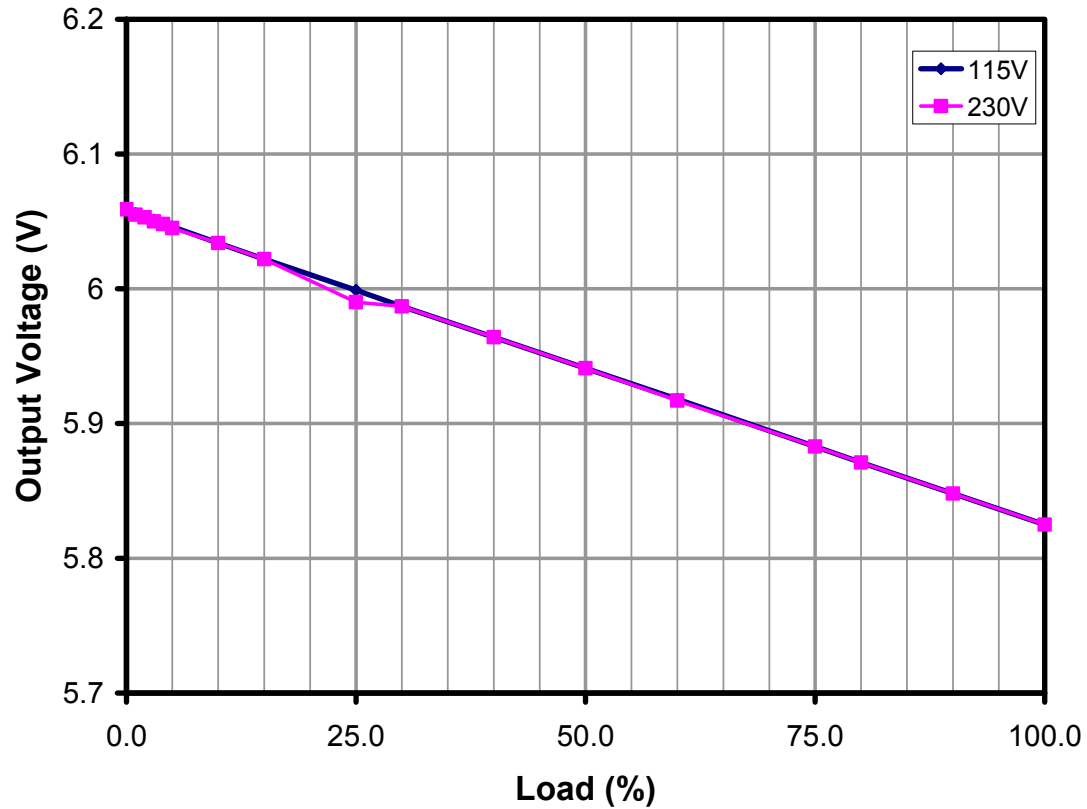

Figure 13 – Load Regulation, Room Temperature.

Note: Drop in output voltage due to 0.23 V resistive drop caused by output cable.



10.6.2 Line

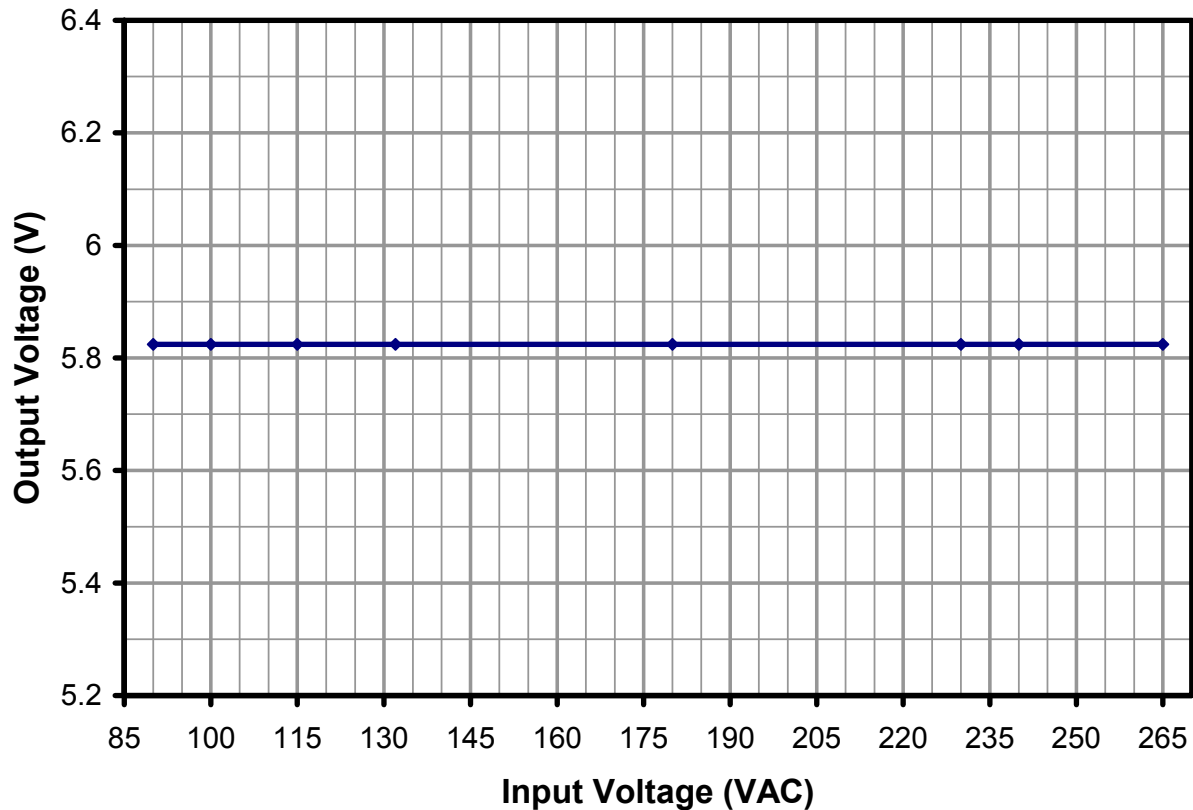

Figure 14 – Line Regulation, Room Temperature, Full Load.



11 Thermal Performance

The power supply was placed inside a plastic case and sealed, without potting material. The supply was heated, with no airflow (placed inside cardboard box), for at least two hours and measurements were taken immediately.

The power supply went through a burn-in cycle, which involved running it inside an oven for 12 hours in a 40 °C ambient temperature condition at maximum load. The unit did not at any time go into thermal shutdown.

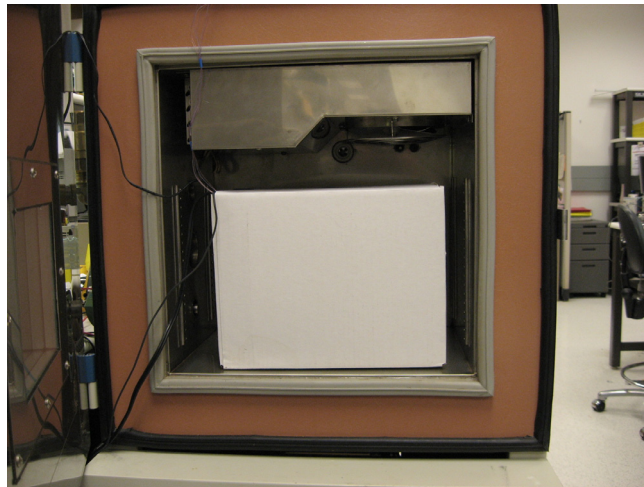

Figure 15 – Carton box, with Power Supply Adapter Inside, Placed in Oven for Burn-in.

Item	Temperature (°C)			
	90 VAC	115 VAC	230 VAC	265 VAC
Ambient	41.2	40.5	40.03	41.1
TRF winding	92.9	89	91.4	94.5
TRF core	92	88.4	91	94
Output Rectifier Case	100.3	96.9	98.6	101.2
Bridge	70.5	63	55	55.5
TOP254 (SOURCE pin)	95.5	86.5	79.2	85.7
CMC	77.2	68.7	60.2	62.2



12 Waveforms

12.1 Drain Voltage and Current, Normal Operation

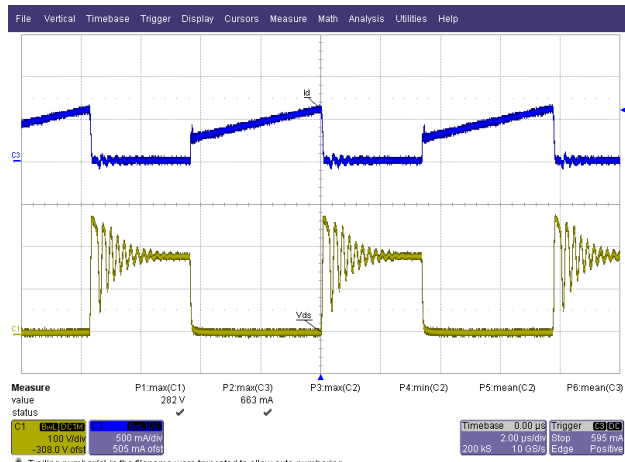

Figure 16 – 85 VAC, Full Load.
 Upper: I_{DRAIN} , 0.5 A / div.
 Lower: V_{DRAIN} , 100 V, 2 μ s / div.

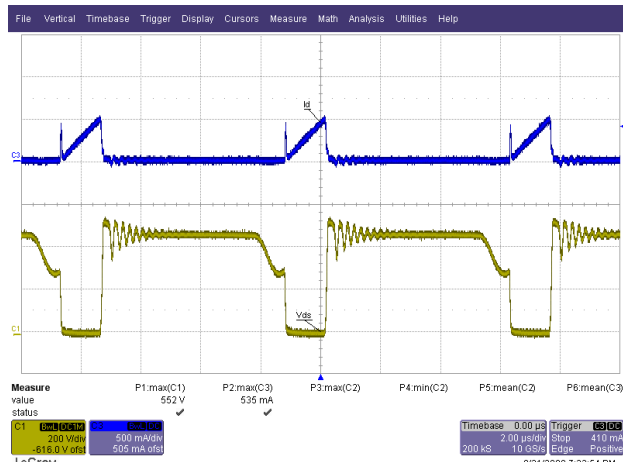

Figure 17 – 265 VAC, Full Load.
 Upper: I_{DRAIN} , 0.5 A / div.
 Lower: V_{DRAIN} , 200 V / div.

12.2 Output Voltage Start-up Profile

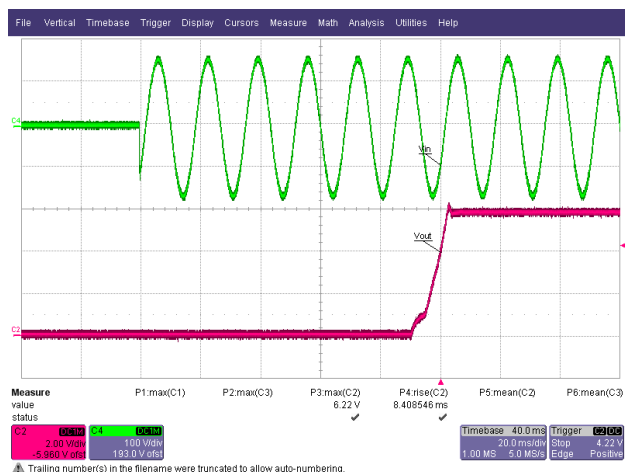

Figure 18 – Start-up Profile, 115 VAC,
 20 ms / div.
 Upper: V_{IN} , 100 V / div.
 Lower: V_{OUT} , 2 V / div.

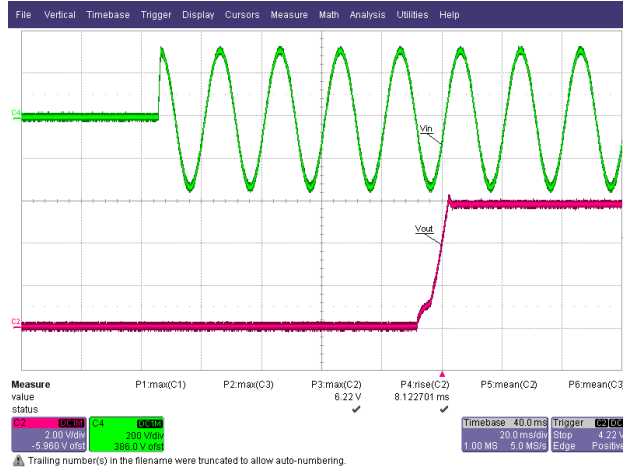

Figure 19 – Start-up Profile, 230 VAC,
 20 ms / div.
 Upper: V_{IN} , 200 V / div.
 Lower: V_{OUT} , 2 V / div.



12.3 Drain Voltage and Current Start-up Profile

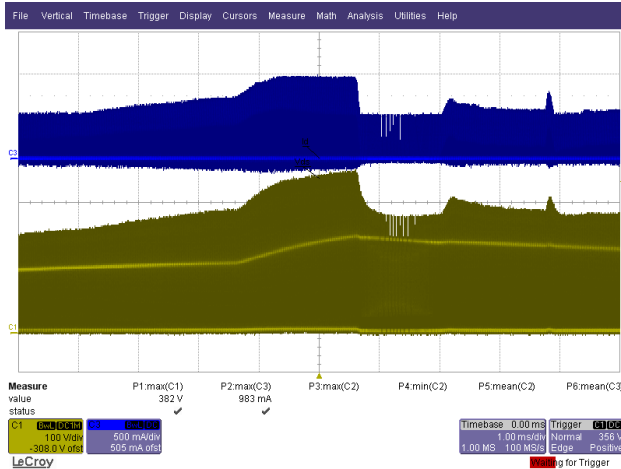

Figure 20 – 85 VAC Input and Maximum Load.
Upper: I_{DRAIN} , 0.5 A / div.
Lower: V_{DRAIN} , 100 V & 1 ms / div.

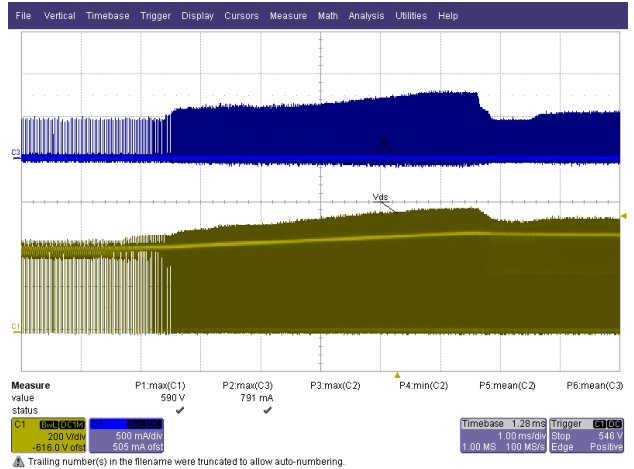

Figure 21 – 265 VAC Input and Maximum Load.
Upper: I_{DRAIN} , 0.5 A / div.
Lower: V_{DRAIN} , 200 V & 1 ms / div.

12.4 Load Transient Response (75% to 100% Load Step)

In the figures shown below, signal averaging was used to better enable viewing the load transient response. The oscilloscope was triggered using the load current step as a trigger source. Since the output switching and line frequency occur essentially at random with respect to the load transient, contributions to the output ripple from these sources will average out, leaving the contribution only from the load step response.

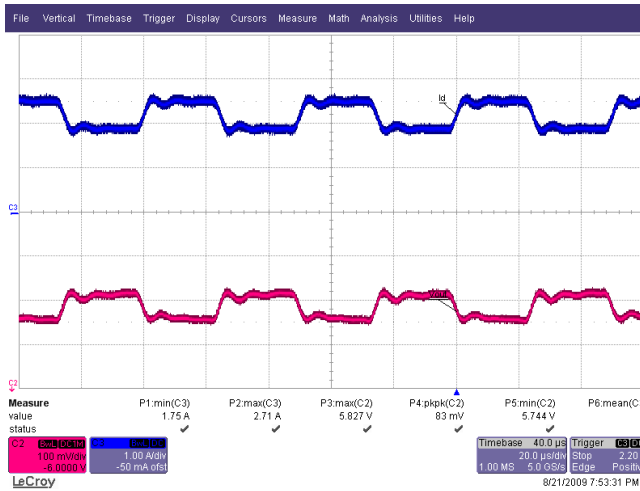

Figure 22 – Transient Response, 115 VAC,
75-100-75% Load Step.
Upper: Load Current, 1 A / div.
Lower: V_{OUT} , 50 mV, 500 μ s / div.

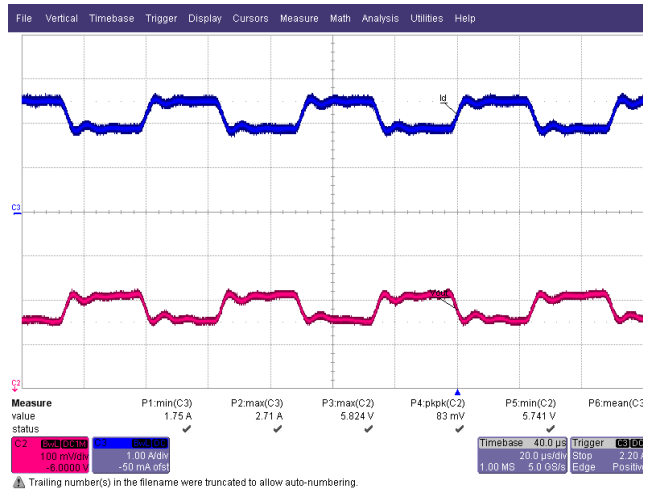

Figure 23 – Transient Response, 230 VAC,
75-100-75% Load Step
Upper: Load Current, 1 A / div.
Lower: V_{OUT} , 50 mV, 2 ms / div.



12.5 Output Ripple Measurements

12.5.1 Ripple Measurement Technique

For DC output ripple measurements, a modified oscilloscope test probe must be utilized in order to reduce spurious signals due to pickup. Details of the probe modification are provided in the Figures below.

The 4987BA probe adapter is affixed with two capacitors tied in parallel across the probe tip. The capacitors include one (1) 0.1 $\mu\text{F}/50\text{ V}$ ceramic type and one (1) 1.0 $\mu\text{F}/50\text{ V}$ aluminum electrolytic. The aluminum electrolytic type capacitor is polarized, so proper polarity across DC outputs must be maintained (see below).

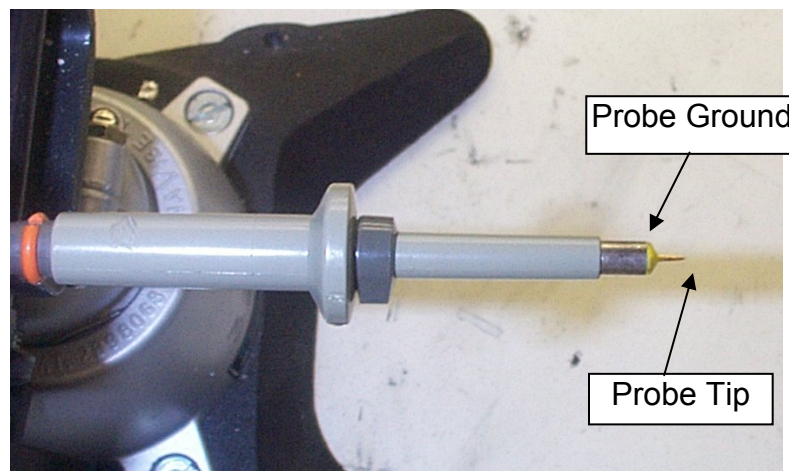

Figure 24 – Oscilloscope Probe Prepared for Ripple Measurement. (End Cap and Ground Lead Removed)

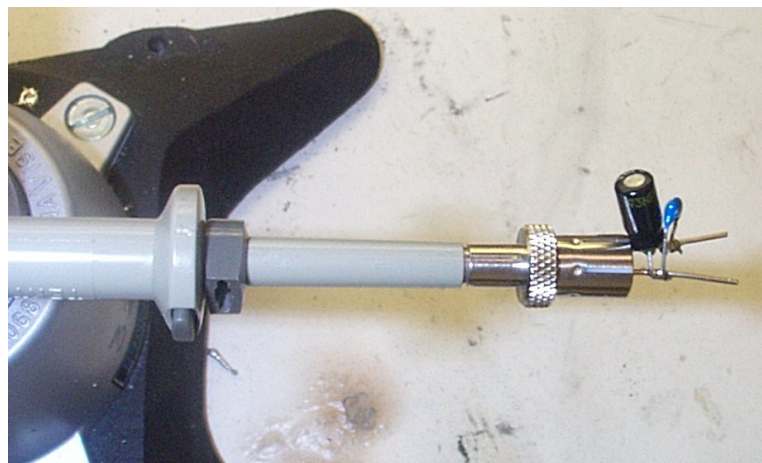

Figure 25 – Oscilloscope Probe with Probe Master (www.probemaster.com) 4987A BNC Adapter. (Modified with wires for ripple measurement, and two parallel decoupling capacitors added)



12.5.2 Measurement Results

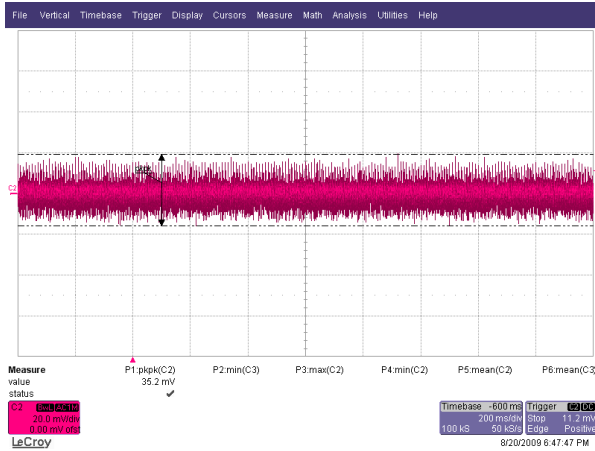

Figure 26 – Ripple [35 mV_{PP}], 90 VAC, Full Load.
200 ms, 20 mV / div.

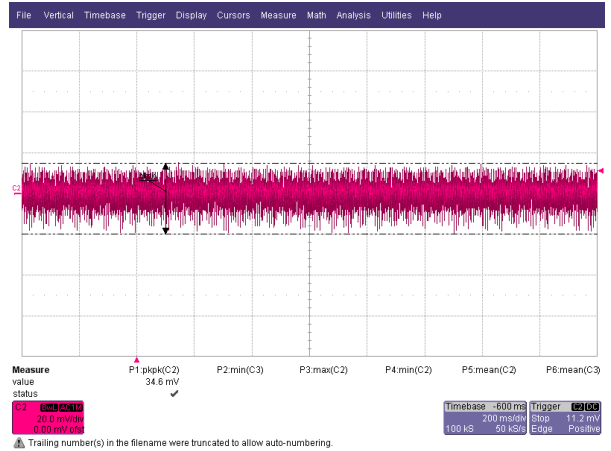

Figure 27 – Ripple [35 mV_{PP}], 115 VAC, Full Load.
200 ms, 52 mV / div.

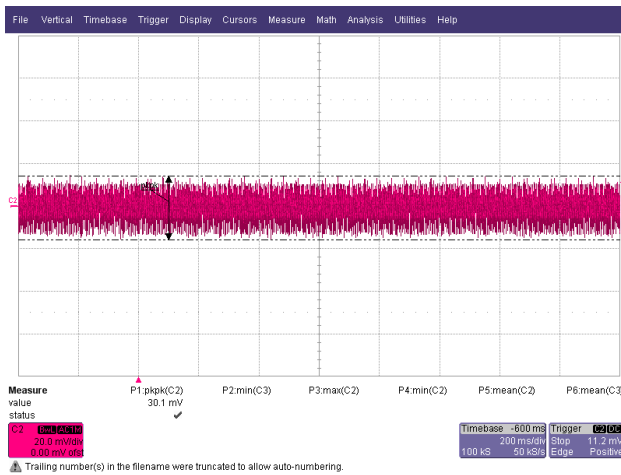

Figure 28 – Ripple [30 mV_{PP}], 230 VAC, Full Load.
200 ms, 20 mV /div.

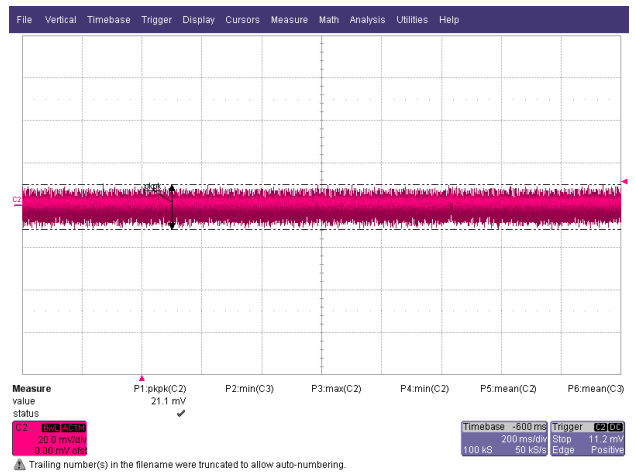

Figure 29 – Ripple [21 mV_{PP}], 265 VAC, Full Load.
200 ms, 20 mV /div.

13 Control Loop Measurements

Venable System equipment was used to gather this data.

13.1 115 VAC Maximum Load

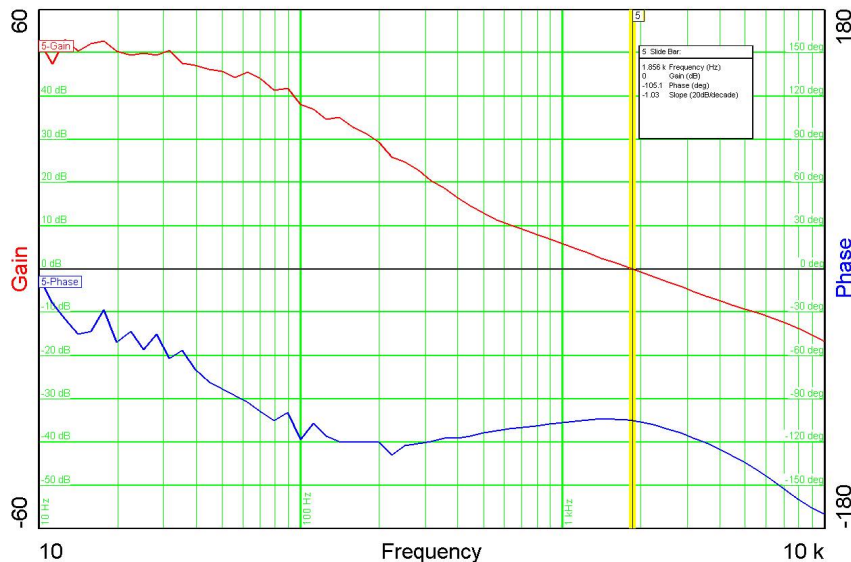

Figure 30 – Gain-Phase Plot, 180 VAC, Maximum Steady State Load
 Vertical Scale: Gain = 10 dB / div, Phase = 30 °/ div.
 Crossover Frequency = 1.85 kHz Phase Margin = 75°

13.2 230 VAC Maximum Load

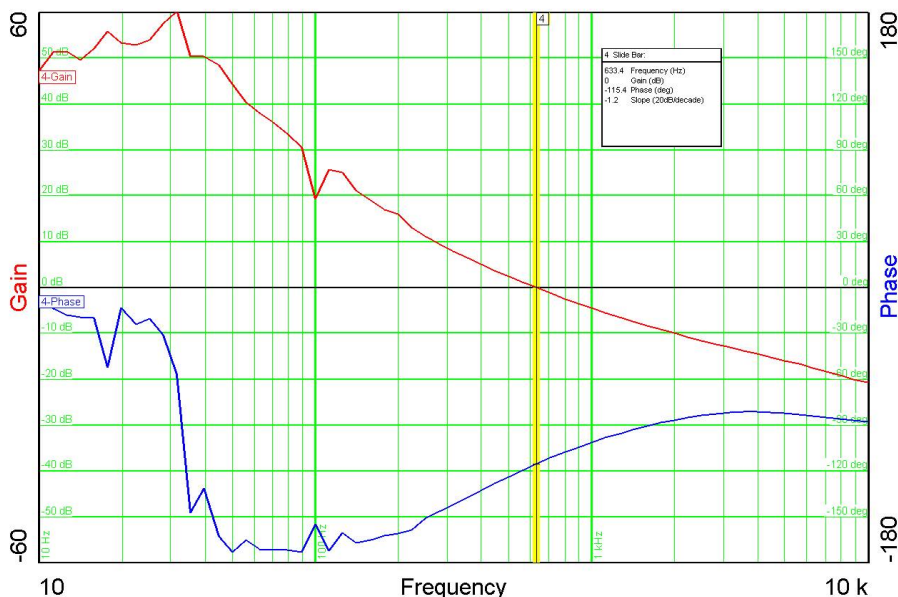

Figure 31 – Gain-Phase Plot, 230 VAC, Maximum Steady State Load
 Vertical Scale: Gain = 10 dB / div, Phase = 50 °/ div.
 Crossover Frequency = 831 Hz, Phase Margin = 79.4°



14 Conducted EMI

Equipment used: Rohde and Schwarz ESPI3 (PN: m1142.8007.03 / EMI Test Receiver 9 kHz to 3 GHz).

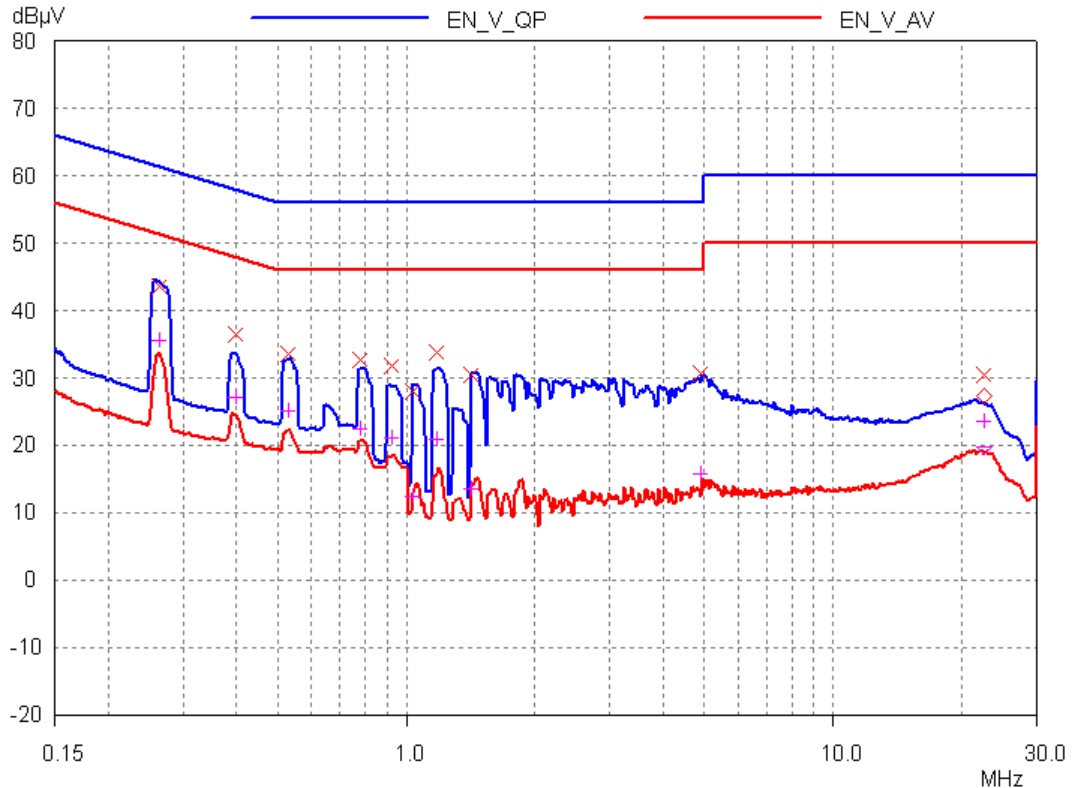

Figure 32 – Conducted EMI, Maximum Steady State Load, 115 VAC, 60 Hz, and EN5022 B Limits. Output Return Not Connected to PE (Floating).

Frequency MHz	Quasi Pk dBµV	Limit dBµV	Delta dB	Phase /PE	Average dBµV	Limit dBµV	Delta dB	Phase /PE
0.26411	43.63	61.30	17.67	L1/gnd	35.52	51.30	15.78	L1/gnd
0.3997	36.37	57.86	21.49	N /gnd	27.02	47.86	20.84	N /gnd
0.52826	33.60	56.00	22.40	L1/gnd	25.12	46.00	20.88	L1/gnd
0.78058	32.61	56.00	23.39	L1/gnd	22.46	46.00	23.54	L1/gnd
0.92276	31.74	56.00	24.26	L1/gnd	21.02	46.00	24.98	L1/gnd
1.03166	28.05	56.00	27.95	L1/gnd	12.50	46.00	33.50	L1/gnd
1.18132	33.88	56.00	22.12	L1/gnd	20.89	46.00	25.11	L1/gnd
1.41893	30.51	56.00	25.49	L1/gnd	13.46	46.00	32.54	L1/gnd
4.87914	30.78	56.00	25.22	N /gnd	15.86	46.00	30.14	N /gnd
22.53024	30.45	60.00	29.55	N /gnd	23.53	50.00	26.47	N /gnd

Table 1 – Data for Figure 32.

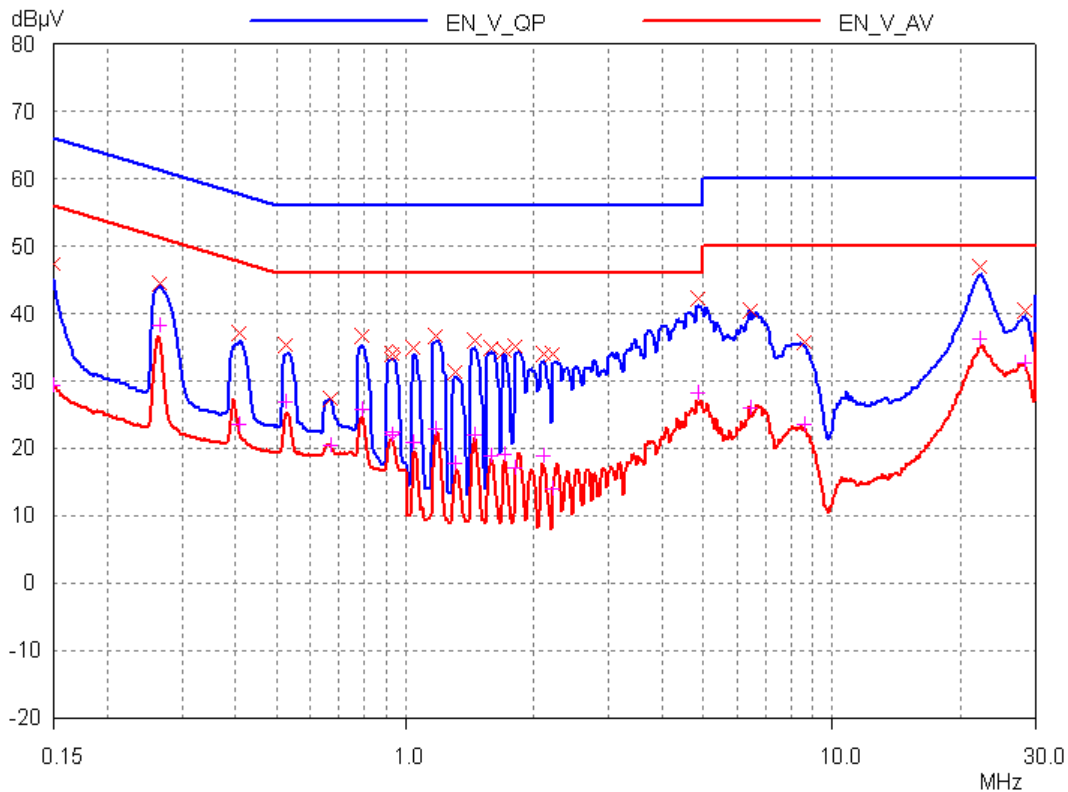

Figure 33 – Conducted EMI, Maximum Steady State Load, 115 VAC, 60 Hz, and EN55022 B Limits. Output Return Connected to PE.

Frequency MHz	Quasi Pk dBµV	Limit dBµV	Delta dB	Phase /PE	Average dBµV	Limit dBµV	Delta dB	Phase /PE
0.15	47.29	66.00	18.71	L1/gnd	29.29	56.00	26.71	L1/gnd
0.26622	44.56	61.24	16.68	L1/gnd	38.31	51.24	12.93	N /gnd
0.40937	37.04	57.66	20.62	N /gnd	23.45	47.66	24.21	N /gnd
0.52407	35.31	56.00	20.69	N /gnd	26.99	46.00	19.01	N /gnd
0.67092	27.31	56.00	28.69	L1/gnd	20.37	46.00	25.63	N /gnd
0.79312	36.58	56.00	19.42	N /gnd	25.67	46.00	20.33	N /gnd
0.93015	34.09	56.00	21.91	L1/gnd	22.09	46.00	23.91	L1/gnd
1.04824	34.89	56.00	21.11	N /gnd	20.91	46.00	25.09	N /gnd
1.18132	36.65	56.00	19.35	L1/gnd	22.85	46.00	23.15	L1/gnd
1.31025	31.38	56.00	24.62	N /gnd	17.79	46.00	28.21	N /gnd
1.45325	35.96	56.00	20.04	L1/gnd	21.92	46.00	24.08	L1/gnd
1.58638	34.81	56.00	21.19	L1/gnd	18.87	46.00	27.13	L1/gnd
1.71796	34.51	56.00	21.49	L1/gnd	19.00	46.00	27.00	N /gnd
1.81651	35.08	56.00	20.92	L1/gnd	17.18	46.00	28.82	L1/gnd
2.11343	33.90	56.00	22.10	L1/gnd	18.84	46.00	27.16	L1/gnd
2.19933	33.97	56.00	22.03	L1/gnd	14.03	46.00	31.97	N /gnd
4.84042	42.32	56.00	13.68	N /gnd	28.29	46.00	17.71	N /gnd
6.39737	40.35	60.00	19.65	N /gnd	26.05	50.00	23.95	N /gnd
8.59095	35.72	60.00	24.28	N /gnd	23.64	50.00	26.36	N /gnd
22.17404	46.85	60.00	13.15	N /gnd	36.14	50.00	13.86	N /gnd
28.16182	40.35	60.00	19.65	N /gnd	32.61	50.00	17.39	N /gnd

Table 2 – Data for Figure 33.



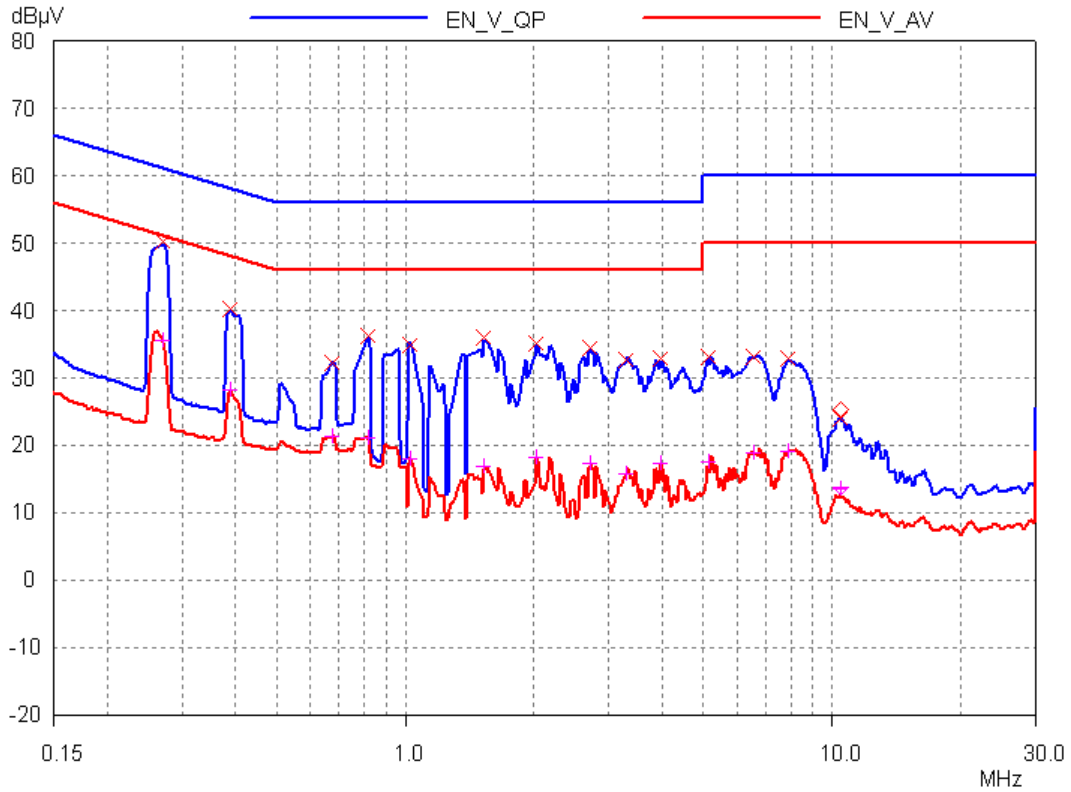

Figure 34 – Conducted EMI, Maximum Steady State Load, 230 VAC, 60 Hz, and EN55022 B Limits. Output Return Not Connected to PE (Floating).

Frequency MHz	Quasi Pk dBµV	Limit dBµV	Delta dB	Phase /PE	Average dBµV	Limit dBµV	Delta dB	Phase /PE
0.2705	50.17	61.10	10.93	L1/gnd	35.65	51.10	15.45	L1/gnd
0.38716	40.18	58.12	17.94	L1/gnd	28.15	48.12	19.97	L1/gnd
0.67628	32.28	56.00	23.72	L1/gnd	21.25	46.00	24.75	L1/gnd
0.81881	36.15	56.00	19.85	L1/gnd	21.08	46.00	24.92	L1/gnd
1.02348	34.93	56.00	21.07	L1/gnd	18.04	46.00	27.96	L1/gnd
1.52442	35.99	56.00	20.01	L1/gnd	16.86	46.00	29.14	L1/gnd
2.03087	35.19	56.00	20.81	L1/gnd	18.11	46.00	27.89	L1/gnd
2.68413	34.45	56.00	21.55	L1/gnd	17.28	46.00	28.72	L1/gnd
3.27579	32.58	56.00	23.42	L1/gnd	15.74	46.00	30.26	L1/gnd
3.93468	32.79	56.00	23.21	L1/gnd	17.31	46.00	28.69	L1/gnd
5.11807	33.17	60.00	26.83	N /gnd	17.62	50.00	32.38	N /gnd
6.50014	33.02	60.00	26.98	L1/gnd	18.96	50.00	31.04	L1/gnd
7.87001	32.95	60.00	27.05	L1/gnd	19.10	50.00	30.90	N /gnd
10.40146	24.00	60.00	36.00	L1/gnd	13.50	50.00	36.50	L1/gnd

Table 3 – Data for Figure 34.



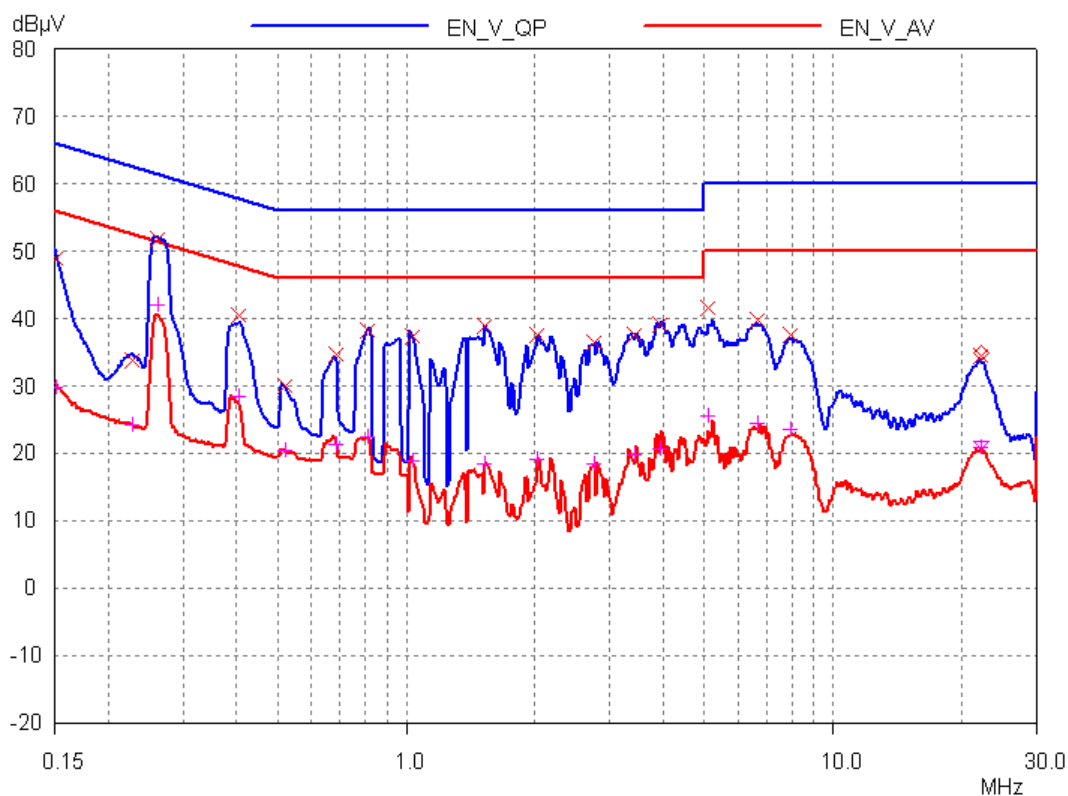

Figure 35 – Conducted EMI, Maximum Steady State Load, 230 VAC, 60 Hz, and EN55022 B Limits. Output Return Connected to PE.

Frequency MHz	Quasi Pk dBµV	Limit dBµV	Delta dB	Phase /PE	Average dBµV	Limit dBµV	Delta dB	Phase /PE
0.1512	48.96	65.93	16.97	L1/gnd	29.70	55.93	26.23	L1/gnd
0.227	33.86	62.56	28.70	L1/gnd	24.14	52.56	28.42	L1/gnd
0.26201	51.91	61.37	9.46	L1/gnd	42.05	51.37	9.32	N /gnd
0.40612	40.39	57.73	17.34	N /gnd	28.49	47.73	19.24	N /gnd
0.51991	30.04	56.00	25.96	L1/gnd	20.43	46.00	25.57	L1/gnd
0.68715	34.72	56.00	21.28	N /gnd	21.34	46.00	24.66	N /gnd
0.81231	38.28	56.00	17.72	L1/gnd	22.51	46.00	23.49	N /gnd
1.03166	37.34	56.00	18.66	L1/gnd	18.91	46.00	27.09	L1/gnd
1.52442	38.87	56.00	17.13	L1/gnd	18.47	46.00	27.53	L1/gnd
2.03087	37.46	56.00	18.54	L1/gnd	19.18	46.00	26.82	L1/gnd
2.72724	36.48	56.00	19.52	N /gnd	18.41	46.00	27.59	N /gnd
3.40894	37.67	56.00	18.33	N /gnd	19.84	46.00	26.16	N /gnd
3.90345	39.04	56.00	16.96	L1/gnd	20.76	46.00	25.24	N /gnd
5.07745	41.57	60.00	18.43	N /gnd	25.46	50.00	24.54	N /gnd
6.60456	39.80	60.00	20.20	L1/gnd	24.41	50.00	25.59	N /gnd
7.93297	37.54	60.00	22.46	N /gnd	23.49	50.00	26.51	N /gnd
22.17404	34.37	60.00	25.63	N /gnd	20.90	50.00	29.10	N /gnd

Table 4 – Data for Figure 35.



15 Radiated EMI

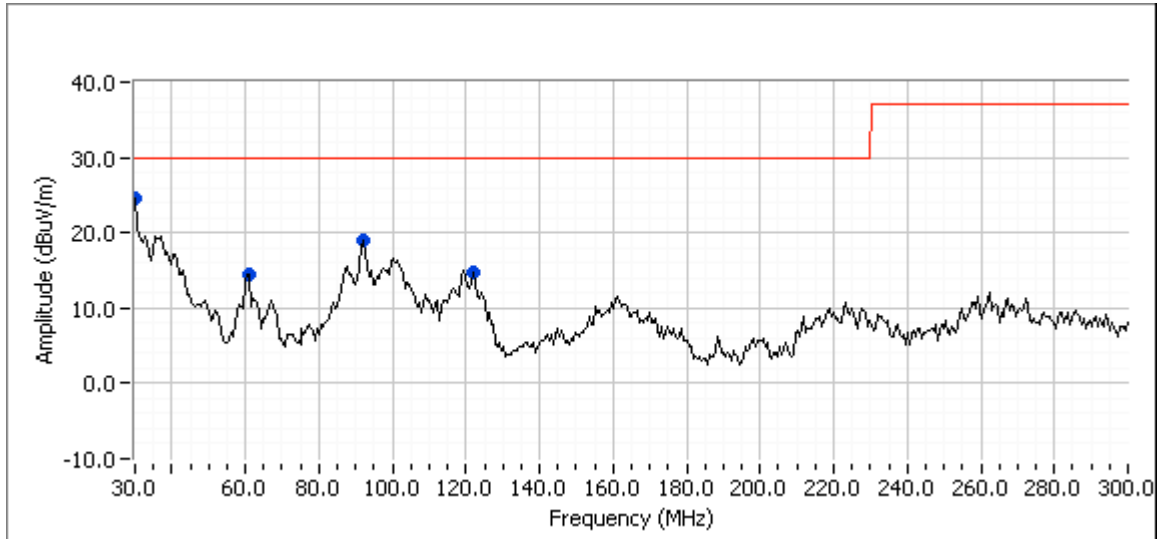

Frequency	Level	Pol	EN55022 Class B		Detector	Azimuth	Height
MHz	dB μ V/m	V/H	Limit	Margin	PK/QP/AVE	Degrees	Meters
30.000	24.6	V	30.0	-5.4	Peak	111	1.0
30.000	21.9	V	30.0	-8.1	QP	111	1.0
92.224	19.0	V	30.0	-11.0	Peak	90	1.0
121.984	14.7	V	30.0	-15.3	Peak	136	1.0
60.842	14.4	V	30.0	-15.6	Peak	200	1.0

Figure 36 – Radiated EMI, Maximum Steady State Load, 120 VAC, 50 Hz, and EN55022 B Limits.



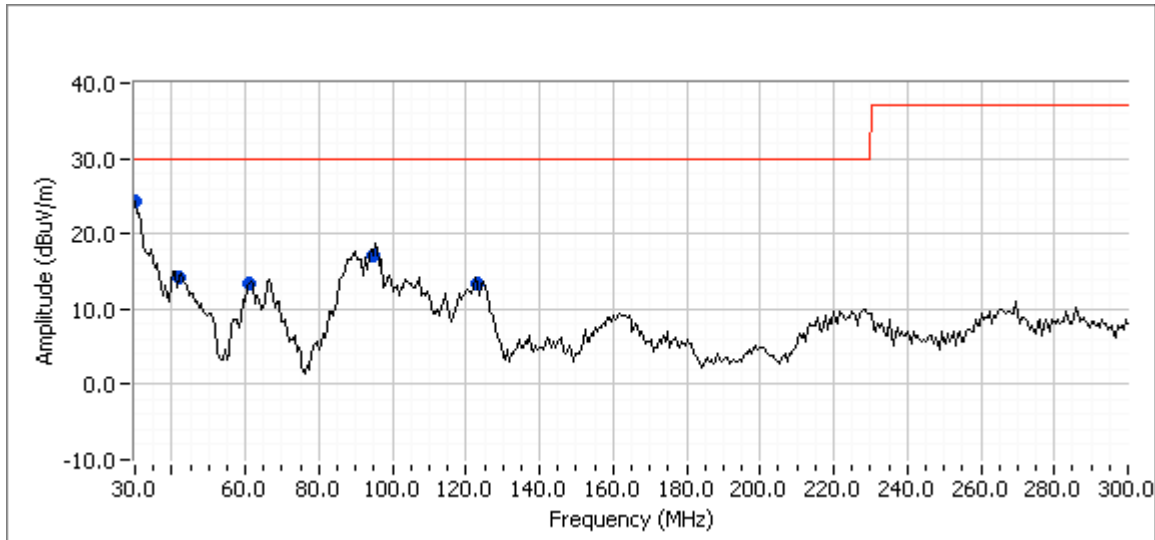

Frequency	Level	Pol	EN55022 Class B		Detector	Azimuth	Height
MHz	dBµV/m	V/H	Limit	Margin	Pk/QP/Avg	Degrees	Meters
30.303	24.4	V	30.0	-5.6	Peak	25	1.0
30.303	19.9	V	30.0	-10.1	QP	25	1.0
41.904	14.2	V	30.0	-15.8	Peak	33	2.0
60.842	13.4	V	30.0	-16.6	Peak	65	1.0
94.930	17.2	V	30.0	-12.8	Peak	193	1.0
123.066	13.3	V	30.0	-16.7	Peak	135	1.0

Figure 37 – Radiated EMI, Maximum Steady State Load, 230 VAC, 60 Hz, and EN55022 B Limits.



16 Revision History

Date	Author	Revision	Description & changes	Reviewed
17-Sep-09	JDC	1.0	Initial Release	Apps & Mktg



For the latest updates, visit our website: www.powerint.com

Power Integrations reserves the right to make changes to its products at any time to improve reliability or manufacturability. Power Integrations does not assume any liability arising from the use of any device or circuit described herein. POWER INTEGRATIONS MAKES NO WARRANTY HEREIN AND SPECIFICALLY DISCLAIMS ALL WARRANTIES INCLUDING, WITHOUT LIMITATION, THE IMPLIED WARRANTIES OF MERCHANTABILITY, FITNESS FOR A PARTICULAR PURPOSE, AND NON-INFRINGEMENT OF THIRD PARTY RIGHTS.

PATENT INFORMATION

The products and applications illustrated herein (including transformer construction and circuits' external to the products) may be covered by one or more U.S. and foreign patents, or potentially by pending U.S. and foreign patent applications assigned to Power Integrations. A complete list of Power Integrations' patents may be found at www.powerint.com. Power Integrations grants its customers a license under certain patent rights as set forth at <http://www.powerint.com/ip.htm>.

The PI Logo, TOPSwitch, TinySwitch, LinkSwitch, LYTSwitch, DPA-Switch, PeakSwitch, CAPZero, SENZero, LinkZero, HiperPFS, HiperTFS, HiperLCS, Qspeed, EcoSmart, Clampless, E-Shield, Filterfuse, StackFET, PI Expert and PI FACTS are trademarks of Power Integrations, Inc. Other trademarks are property of their respective companies. ©Copyright 2013 Power Integrations, Inc.

Power Integrations Worldwide Sales Support Locations

WORLD HEADQUARTERS

5245 Hellyer Avenue
San Jose, CA 95138, USA.
Main: +1-408-414-9200
Customer Service:
Phone: +1-408-414-9665
Fax: +1-408-414-9765
e-mail: usasales@powerint.com

GERMANY

Lindwurmstrasse 114
80337, Munich
Germany
Phone: +49-895-527-39110
Fax: +49-895-527-39200
e-mail: eurosales@powerint.com

JAPAN

Kosei Dai-3 Building
2-12-11, Shin-Yokohama,
Kohoku-ku, Yokohama-shi,
Kanagawa 222-0033
Japan
Phone: +81-45-471-1021
Fax: +81-45-471-3717
e-mail: japansales@powerint.com

TAIWAN

5F, No. 318, Nei Hu Rd.,
Sec. 1
Nei Hu District
Taipei 11493, Taiwan R.O.C.
Phone: +886-2-2659-4570
Fax: +886-2-2659-4550
e-mail: taiwansales@powerint.com

CHINA (SHANGHAI)

Rm 1601/1610, Tower 1,
Kerry Everbright City
No. 218 Tianmu Road West,
Shanghai, P.R.C. 200070
Phone: +86-21-6354-6323
Fax: +86-21-6354-6325
e-mail: chinasales@powerint.com

INDIA

#1, 14th Main Road
Vasanthanagar
Bangalore-560052
India
Phone: +91-80-4113-8020
Fax: +91-80-4113-8023
e-mail: indiasales@powerint.com

KOREA

RM 602, 6FL
Korea City Air Terminal B/D,
159-6
Samsung-Dong, Kangnam-Gu,
Seoul, 135-728 Korea
Phone: +82-2-2016-6610
Fax: +82-2-2016-6630
e-mail: koreasales@powerint.com

EUROPE HQ

1st Floor, St. James's House
East Street, Farnham
Surrey GU9 7TJ
United Kingdom
Phone: +44 (0) 1252-730-141
Fax: +44 (0) 1252-727-689
e-mail: eurosales@powerint.com

CHINA (SHENZHEN)

3rd Floor, Block A,
Zhongtuo International Business
Center, No. 1061, Xiang Mei Rd,
FuTian District, ShenZhen,
China, 518040
Phone: +86-755-8379-3243
Fax: +86-755-8379-5828
e-mail: chinasales@powerint.com

ITALY

Via Milanese 20, 3rd Fl.
20099 Sesto San Giovanni
(MI) Italy
Phone: +39-024-550-8701
Fax: +39-028-928-6009
e-mail: eurosales@powerint.com

SINGAPORE

51 Newton Road,
#19-01/05 Goldhill Plaza
Singapore, 308900
Phone: +65-6358-2160
Fax: +65-6358-2015
e-mail: singaporesales@powerint.com

APPLICATIONS HOTLINE

World Wide +1-408-414-9660

APPLICATIONS FAX

World Wide +1-408-414-9760

